



Comprehensive Curriculum

Revised 2008

Grade 4 Science



Louisiana Department of
EDUCATION

Paul G. Pastorek, State Superintendent of Education



**Grade 4
Science**

Table of Contents

Unit 1: Measuring and Comparing	1
Unit 2: Sound, Light, and Heat.....	12
Unit 3: Electricity	28
Unit 4: Living Organisms.....	36
Unit 5: Ecosystems	55
Unit 6: Planet Earth and Its Moon.....	68
Unit 7: Structure and Form of Living Things	93
Unit 8: Foods and Nutrition.....	105

Louisiana Comprehensive Curriculum, Revised 2008 **Course Introduction**

The Louisiana Department of Education issued the *Comprehensive Curriculum* in 2005. The curriculum has been revised based on teacher feedback, an external review by a team of content experts from outside the state, and input from course writers. As in the first edition, the *Louisiana Comprehensive Curriculum*, revised 2008 is aligned with state content standards, as defined by Grade-Level Expectations (GLEs), and organized into coherent, time-bound units with sample activities and classroom assessments to guide teaching and learning. The order of the units ensures that all GLEs to be tested are addressed prior to the administration of *iLEAP* assessments.

District Implementation Guidelines

Local districts are responsible for implementation and monitoring of the *Louisiana Comprehensive Curriculum* and have been delegated the responsibility to decide if

- units are to be taught in the order presented
- substitutions of equivalent activities are allowed
- GLEs can be adequately addressed using fewer activities than presented
- permitted changes are to be made at the district, school, or teacher level

Districts have been requested to inform teachers of decisions made.

Implementation of Activities in the Classroom

Incorporation of activities into lesson plans is critical to the successful implementation of the Louisiana Comprehensive Curriculum. Lesson plans should be designed to introduce students to one or more of the activities, to provide background information and follow-up, and to prepare students for success in mastering the Grade-Level Expectations associated with the activities. Lesson plans should address individual needs of students and should include processes for re-teaching concepts or skills for students who need additional instruction. Appropriate accommodations must be made for students with disabilities.

New Features

Content Area Literacy Strategies are an integral part of approximately one-third of the activities. Strategy names are italicized. The link ([view literacy strategy descriptions](#)) opens a document containing detailed descriptions and examples of the literacy strategies. This document can also be accessed directly at <http://www.louisianaschools.net/1de/uploads/11056.doc>.

A *Materials List* is provided for each activity and *Blackline Masters (BLMs)* are provided to assist in the delivery of activities or to assess student learning. A separate Blackline Master document is provided for each course.

The *Access Guide to the Comprehensive Curriculum* is an online database of suggested strategies, accommodations, assistive technology, and assessment options that may provide greater access to the curriculum activities. The *Access Guide* will be piloted during the 2008-2009 school year in Grades 4 and 8, with other grades to be added over time. Click on the *Access Guide* icon found on the first page of each unit or by going directly to the url <http://mconn.doe.state.la.us/accessguide/default.aspx>.



**Grade 4
Science
Unit 1: Measuring and Comparing**

Time Frame: Approximately two weeks



Unit Description

Taking measurements and making comparisons are two skills that are developed throughout the science units and practiced across the curriculum. In this unit, various investigations require accurate measurements using a variety of tools.

Student Understanding

As students explore the properties of materials, they develop the skill of measuring accurately in both metric and standard U.S. system units and in recording quantitative data. Graphing skills develop as students explore motion and analyze positional changes over time. Students develop the ability to model or diagram the motion of particles in relation to temperature and changes in state. In addition, students should gain skill in separating mixtures and describing separation techniques.

Guiding Questions

1. Can students recognize the effect that size, mass, and volume have on the functioning of a variety of materials?
2. Can students use a graph to illustrate the interrelationship of measurements such as time, speed, and mass?
3. Can students make measurements in and compare the U.S. system and metric units?
4. Can students explain the water cycle?

Unit 1 Grade-Level Expectations (GLEs)

GLE #	GLE Text and Benchmarks
Science as Inquiry	
1.	Ask questions about objects and events in the environment (e.g., plants, rocks, storms) (SI-E-A1)
2.	Pose questions that can be answered by using students' own observations, scientific knowledge, and testable scientific investigations (SI-E-A1)
3.	Use observations to design and conduct simple investigations or experiments to answer testable questions (SI-E-A2)

GLE #	GLE Text and Benchmarks
4.	Predict and anticipate possible outcomes (SI-E-A2)
5.	Identify variables to ensure that only one experimental variable is tested at a time (SI-E-A2)
6.	Use a variety of methods and materials and multiple trials to investigate ideas (observe, measure, accurately record data) (SI-E-A2)
8.	Measure and record length, temperature, mass, volume, and area in both metric system and U.S. system units (SI-E-A4)
9.	Select and use developmentally appropriate equipment and tools (e.g., magnifying lenses, microscopes, graduated cylinders) and units of measurement to observe and collect data (SI-E-A4)
10.	Express data in a variety of ways by constructing illustrations, graphs, charts, tables, concept maps, and oral and written explanations as appropriate (SI-E-A5) (SI-E-B4)
12.	Use a variety of appropriate formats to describe procedures and to express ideas about demonstrations or experiments (e.g., drawings, journals, reports, presentations, exhibitions, portfolios) (SI-E-A6)
13.	Identify and use appropriate safety procedures and equipment when conducting investigations (e.g., gloves, goggles, hair ties) (SI-E-A7)
21.	Use evidence from previous investigations to ask additional questions and to initiate further explorations (SI-E-B6)
Physical Science	
23.	Determine linear, volume, and weight/mass measurements by using both metric system and U.S. system units to compare the results (PS-E-A2)
24.	Illustrate how heating/cooling affects the motion of small particles in different phases of matter (PS-E-A4)
25.	Describe various methods to separate mixtures (e.g., evaporation, condensation, filtration, magnetism) (PS-E-A5)
26.	Measure, record, and graph changes in position over time (e.g., speed of cars, ball rolling down inclined plane) (PS-E-B3)
58.	Draw, label, and explain the components of a water cycle (ESS-E-A3)

Sample Activities

Activity 1: Safety in the Lab (GLEs: 13)

Materials List: poster boards, Science Safety Contract BLM (1 per student)

To ensure the safety of all students in the lab, students should be instructed on the science safety procedures. Teachers can obtain safety guidelines using the link, “*Science and Safety*” *It’s Elementary Flip Chart*, at www.csss-science.org/downloads/scisaf_cal.pdf. Briefly discuss school safety rules and why the rules are established. Ask students what they know about safety in the science classroom and why it is important. Through questioning, guide students in creating a list of safety rules to be used during science labs.

Each student will choose one lab rule and create a mini-poster for the rule. Students will share their posters with the class. Posters will be hung on the wall all year for reference. Prior to lab investigations, students should identify lab rules that will be needed for that investigation. The teacher, student, and parent should sign a safety contract. See Science Safety Contract BLM.

Activity 2: Measuring Length, Mass, and Volume of a Regular Solid (GLEs: 6, 8, 9, 10, 12, 23)

Materials List: transparent overhead ruler, transparencies, rulers, paper clips, markers, crayons, balance scale, shoe box, 1 inch by 1 inch cubes, cereal boxes, rectangular boxes, tape measure, Toy Measurement Chart BLM (1 per student)

A. Ask the students “Think about times in your life when you have measured or have seen someone measure the length of objects.” Have students *brainstorm* ([view literacy strategy descriptions](#)) a list of tools used to measure the length of an object. Hold up an example of each tool and discuss what a scientist may measure with each tool. Teacher will model how to use an overhead ruler to measure lines drawn on a transparency to the nearest half inch and nearest centimeter. Students will practice measuring drawn lines and then real classroom objects (such as paper clips, markers, books, highlighters, crayons, etc.) to nearest half inch and centimeter.

B. Have students *brainstorm* a list of tools used to measure the mass of an object. Discuss each tool used to measure mass. Model how to use a balance scale to measure mass. Have students measure the objects in grams.

C. Ask students to bring in a stuffed animal, an action figure, a fashion doll, or similar item, that has arms and legs that they can easily use to measure. Establish the location of the placement of the tape measure for each measurement so that there is consistency in the measurements. Have students record their measurements on the Toy Measurement Chart BLM. Model how to measure objects using a tape measure. Students will take the requested measurements on their toy and themselves in both units, recording each. Students should work in pairs to help each other with awkward measurements. After allowing time to complete the measurements, teachers should discuss with students how their measurements compared with the toy’s measurements and how the metric system measurements compared with U.S. system units. Create a double bar graph that compares student measurements with those of the toys.

D. Have students fill a shoebox with 1 inch by 1 inch cubes. Have students calculate how many cubes it takes to make a row along the bottom of the box, how many rows it takes to fill 1 layer on the bottom of the box, how many layers it takes to fill the box, and how many total cubes are used to fill the whole box. Explain to students that they have found the “volume” of the box. Operationally define *volume* (guide students with questioning to determine the meaning of volume). Discuss formula for calculating volume of a rectangular solid. ($V = l \times w \times h$). Have students measure the length, width, and height of

the shoebox used above in inches and centimeters and calculate the volume of the box. Compare this total to the total number of cubes it took to fill the box. Then have students measure other rectangular objects such as cereal boxes in inches and centimeters and calculate the volume of those objects.

Activity 3: Measuring Time and Distance (GLEs: 1, 2, 3, 4, 5, 6, 8, 9, 10, 12, 23, 26)

Materials List: sheets of strong flat cardboard, 4 film canister racers per student group (empty black and gray film canisters, popcorn kernels, low-temp hot glue gun), books, meter sticks, stopwatches, calculators, data tables, graphing paper, color pencils, Film Canister Racing Data Table BLM (1 per student), student science learning logs

Teacher note: Toy dump trucks with added weights may be substituted for the film canisters.

Have students generate ideas that may influence speed. Ask them if an object will travel faster down a low hill or a higher hill? Have the students write a prediction in their science *learning log* ([view literacy strategy descriptions](#)).

A science *learning log* is a strategy that enables the students to record ideas, questions, reactions, and new understanding related to content. It provides a means for students to refine their thinking as the learning occurs.

A. Have students design an investigation to measure time and distance to calculate the speed of film canisters with various masses traveling on a track of varying heights. Prior to the activity, hot glue another film canister lid (using the top side of the lid) to the bottom of an empty capped film canister. (See diagram below)

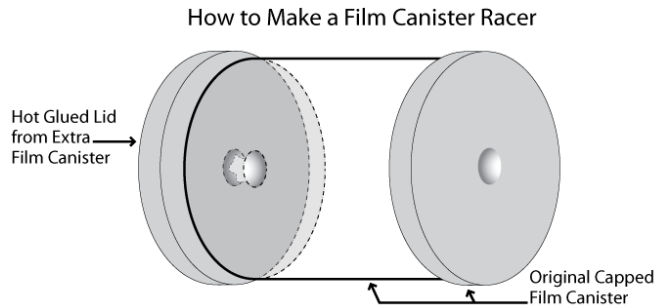

(Note: Use the black and gray film canisters and not the translucent ones. When hot gluing, make sure that you place the dab of hot glue in the indentation in the bottom of the canister and use the bump on the inside of the lid to be glued to line up the dab of glue and the cap. Otherwise the racer will not work.) The lids will act like a type of “wheel” on the canister. Have students, working in teams of 3 – 4, fill and label the first film canister with 10 popcorn seeds and mass the canister. Then have students fill and label other canisters with 25, 50, and 100 seeds respectively and mass them. The masses

should be recorded in a data table (Film Canister Racing Data Table BLM). Students will create the track by propping a piece of strong flat cardboard on a stack of books at varying heights. Elevate one end of the track using a book. Have students measure and record the length of the cardboard and the height of the stack of books in centimeters. As one student releases the film canister with 10 seeds from the top of the cardboard another student uses a stopwatch to measure the time it takes for the canister to roll to the end of the track. Have students perform a few trial releases so that the student with the stopwatch can become proficient with timing. Repeat the task three times and record the results of each trial. Repeat the whole procedure using the 25, 50, and 100 seed canisters. Average the three trials for each canister using a calculator if available. To calculate the speed of film canisters, divide the distance by the time. Have students increase the elevation of one end of the track, record the height, and repeat the procedure recording the results as mentioned above. Repeat the test at a third height. Have students identify the experimental variable that they are testing in the investigation. Instruct students to graph the results of all three events for all four canisters (use a different color pencil for each canister). Review the required graphing skills as needed. Have students compare their results to those from other groups. Discuss, looking for trends in the data. Discuss the effect that changing the elevation had on the speed of the film canister and the amount of time it took to travel down the cardboard track. Ask what effect increasing the elevation had on the speed. Help students relate the increase in height to an increase in energy. Discuss the effect that changing the mass of each canister had on the speed of the film canister and the amount of time it took to travel down the cardboard track. Ask what effect changing the mass of the canister had on the speed. Have students complete the investigation design by forming a conclusion to the investigation.

Activity 4: Temperature Effects (GLEs: 2, 3, 5, 6, 10, 12, 13, 24)

Materials List: popcorn seeds, plastic petri dishes, food coloring, clear tape, hot plate or electric hot pot, ice chest or freezer, blow dryer, tape measure, goggles, oven mitt, ice, water, disposable aluminum pans, balloons, , clear plastic cups, tea bags, stopwatches, chart paper, Temperature Effects Data Table BLM (1 per student), science learning logs

Safety Note: To prevent injuries, use plastic petri dishes to prevent injuries from broken glass. Have students identify safety procedures and equipment needed when using electricity and warm water. In working with heated water, be sure that the water used is not hot enough to cause a burn, be sure that water is not located near electrical devices and that work surfaces are stable. Never drink any liquids used in lab investigations.

Part A:

Before starting the activity, give students the following *SQPL (Student Questions for Purposeful Learning)* prompt ([view literacy strategy descriptions](#)). “All matter is made of particles, and temperature affects the arrangement of those particles in the matter.” Instruct students to work in pairs to generate questions related to the prompt. Have

students share their questions, recording them on chart paper for later use. If the students do not list some key questions, contribute your own questions to the list.

SQPL is a literacy strategy that activates and builds relevant prior knowledge about a topic to be studied and sets meaningful purposes for reading and learning. *SQPL* is a procedure in which the teacher generates a statement related to the material to be read or covered in the day's lesson that would cause students to wonder, challenge, and question. Students then generate questions related to the prompt, share their questions, and later use the questions to guide their reading as they search for answers.

Prior to the activity, the teacher should create models of the particles in the three states of matter for each group. Using food coloring, dye three popcorn seeds blue and three red for each group. To create a solid model, completely fill a plastic petri dish with a lid with popcorn seeds including one blue and one red. Make sure that the blue and red seeds are visible in the model. (*Safety Note: To prevent injuries, use plastic petri dishes to prevent injuries from broken glass.*) Place the lid on the dish and use clear tape to tape the top to the bottom to prevent spilling. To create a liquid model, fill just the bottom of the petri dish with popcorn seeds including one red and one blue seed and tape on the lid. To create a gas model, place 5 popcorn seeds in the petri dish, including one red and one blue seed, and tape on the lid.

The students will use their science *learning logs* ([view literacy strategy descriptions](#)) to record an initial drawing of where they predict the particles are positioned in a solid, liquid, and gas and write a prediction explaining the movement of the particles in each state.

Have student groups observe each model and its particles as energy is applied to the model. Have students shake the model of the solid and observe the position and movement of the particles by paying close attention to the movement of the red and blue popcorn kernels. Students should return to their science *learning logs* and draw a picture (see diagrams below) of the position of the particles (popcorn kernels) in a solid and write an explanation of the movement of the particles.

Diagram of Particles in States of Matter

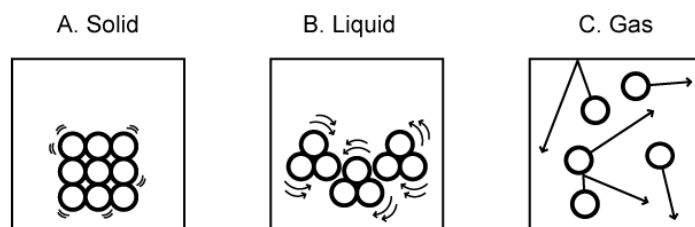

The procedure should be repeated with the liquid and gas models. Have a group discussion on the states of matter and the position and movement of their particles. Guide students to conclude that the particles in solids move but not very much, the

particles in liquids slide over and around each other, and the particles in gases move out faster and farther apart. Also guide students to conclude that as you increase energy, the particles move faster and as you decrease energy, the particles move slower. Have students kinesthetically move around the room to model the arrangement of particles in the three phases.

Return to questions generated by students from the *SQPL* prompt. Using the student observations and appropriate teacher selected reading materials, have the students answer the questions. Discuss questions and correct any misconceptions that occur. Students can later use the *SQPL* prompt as a study guide.

Part B: Following a discussion on gases and how their particles behave, ask students to design a lab to test the effects of temperature on a gas using the materials provided (balloons, ice chest or freezer, hot plate, 2 disposable aluminum pans, blow dryer, tape measure, water, etc.). Be sure to have each group present their design for teacher review and approval before the students begin work on the activity. Some students may choose to test the effects of heating, while others may choose to test the effects of cooling. Have students create a testable question and establish variables and controls. Guide and assist students in designing the procedures. The teacher should provide materials such as balloons. The students may design a lab such as the following. To investigate the effect of temperature on a gas, the student will measure and record the circumference of an inflated balloon in centimeters before and after the balloon is cooled and warmed. Place the inflated balloon in an aluminum pan with ice and water for fifteen minutes or other chosen interval. Measure and record the circumference. Measure and record again after a second interval. Repeat the procedure using warmed water in an aluminum pan. Compare the measurements. Students will set up a table and record the measurements. Conduct a class discussion using the following questions: How does lowering the temperature affect the volume of gas? Is the effect greater over a longer period of time? How does the gas keep the balloon inflated? Why is the volume of air less when the balloon is cold?

Part C: In a guided inquiry, students will investigate how temperature affects the motion of particles of matter. Have students determine the variables and controls for the lab. Provide students with two clear plastic cups and two tea bags. In one cup, pour cold water. Have students measure and record the temperature in the Temperature Effects Data Table BLM. Immediately, put in a tea bag. Using a clock, timer, or stop watch, record time intervals and the appearance of the water being sure to record the time it takes for the color of the water to begin to change. After a specified interval, have students repeat the investigation with the same amount of warm water, being sure to measure the temperature before proceeding. (*Safety note - Hot water can cause a burn. To ensure student safety, make sure water is heated until it is warm but not boiling.*) Have students compare the results, describe the apparent motion observed by the tea infusion, and conclude that heat increases the motion of matter.

Activity 5: Modeling the Water Cycle (GLEs: 1, 3, 5, 6, 9, 10, 12, 21, 24, 25, 58)

Materials List: graduated cylinders, water, ruler, balance scale, salt, plastic sandwich bags, rubber bands, red food coloring, empty water bottles, alcohol thermometers, learning logs

Prior to the investigation, the teacher should thoroughly wash the graduated cylinders and sterilize them if possible. If this is not possible, the teacher should substitute measuring cups for the cylinders that can be washed in a dishwasher or sink. Ask students to think of a day when it rained. Have them describe what happened to the rain during the days after the rained stopped. Guide them to describe that the water dried up and disappeared. Ask them to think about where the water went and develop a testable question.

Have students model the water's disappearance (evaporation), which will lead them to determine where the water went. Using a graduated cylinder, students will measure and record a certain amount of liquid. They will identify a change in volume as the dependent variable. Then, they will place the cylinder (container) in the Sun and record the change in the volume as the liquid evaporates. Encourage students to infer what happened to the liquid. If it is not possible to go outside, then a high intensity lamp or sunlamp can be used to represent the Sun.

Next, students will examine how evaporation can be used to separate a solid from a liquid. Students will pretend that they are afloat in the Gulf of Mexico with no fresh water. They do have a great amount of salt water. Pose the question, "How will you survive without fresh water?" Have students discuss ways to obtain fresh water containing no salt using what they have learned in the earlier investigation. Guide students to pose the question as to how they can separate the salt from the water and to design their own investigation in which they establish controls and a variable. Student designs should involve the measurement of the mass of an amount of salt added to a volume of water in a clean, graduated cylinder or measuring cup. An example investigation would be to stir until the salt is in solution. Place the opening of a small plastic sandwich bag around the top of the cylinder forming a balloon shaped container that will collect the evaporated water. Hold the bag balloon in place with tape or a rubber band to form a seal between the cylinder and the air. Allow the water to evaporate. Using individual disposable spoons, students may taste the water in the bag and may observe salt crystals in the cylinder. Have students relate this investigation to the water cycle.

Later, have students think about all of the water that is evaporated into the atmosphere. What happens to it? Have students think about how the mirror in a bathroom looks after a shower. Have them discuss with their partners where the water came from and why it is there. Guide students to answer the question of how the evaporated water (a gaseous vapor) can again return to (condensed) the liquid state.

Guide students in creating a model that will show how water vapor can be separated from the air in the classroom. Have students pour a measured volume of room-temperature water, colored with red food coloring, into a clear plastic water bottle. Have students

measure the temperature of the air in the room and the temperature of the water. Students will observe the appearance of the exterior of the bottle and record in their journals. Students will place the bottles in a freezer overnight. The following day the bottles will be set upon their desks and observations made of the water droplets, or condensation, that forms on the exterior of the bottle. Review the procedure for using a thermometer and how to read a thermometer. The students will measure the room temperature in the room, the ice in the bottle, and the outside of the bottle. The students will wipe the condensation to confirm that it is water. Ask them where the water came from since it is not red. Help them to conclude that the liquid water is separating from the air in the classroom. Watch as the water forms puddles on their desks. Have students relate the water to rain. Students should observe and record results in their science *learning log* ([view literacy strategy descriptions](#)). The vocabulary words introduced for the water cycle are *evaporation*, *condensation*, and *precipitation*. Define the terms in relation to the model and to the water cycle. Using the student observations and appropriate teacher-selected reading materials, discuss the water cycle and the processes involved. Use drawings or roundhouse diagrams to represent the water cycle and to put all of the ideas in the models together.

Using the *SPAWN* ([view literacy strategy descriptions](#)), have students respond to the following writing W or What if? prompt: *As a class you have just discussed the importance of the water cycle. What would happen to Earth if the water cycle suddenly stopped?* When writing, think of all the things affected by the water cycle and how Earth depends on it. Students should write for about 10 minutes and may write about plants dying from lack of water, the amount of fresh water decreasing, or the lack of rainfall. Students should share their writing with a partner.

SPAWN writing is a form of writing used to promote higher order thinking and writing about topics. *SPAWN* is an acronym that stands for Special Powers, Problem Solving, Alternative Viewpoints, What If? and Next.

Teachers determine the type of higher order thinking they want the students to exhibit, and then write a prompt that promotes the kind of thinking about the content they desire. *SPAWN* prompts can be used as an anticipatory or reflective activity.

Sample Assessments

General Guidelines

Assessment techniques should include use of drawings/illustrations/models, laboratory investigations with reports, laboratory practicals (problem-solving and performance-based assessments), group discussion and journaling (reflective assessment), and paper-and-pencil tests (traditional summative assessments).

- Students should be monitored throughout the work on all activities via teacher observation of the students' work and lab notebook entries.
- All student-developed products should be evaluated as the unit continues.
- For some multiple-choice items on written tests, ask students to write a justification for their chosen response.

General Assessments

- The student will demonstrate ability and understanding in using measurement tools in several tasks.
- The student will assume roles in the king's entourage and act out the story *How Big is a Foot*.
- The student will design and measure lengths in a set of games to be played with a younger class, such as beanbag toss, hopping, skipping, and jumping races.
- The student will correctly label a diagram of the water cycle with explanations of how it functions and with descriptions of how the student would design a lab or create a model to demonstrate the concepts.
- The students will cooperatively design their own investigations of the concepts above, which would include the use of measurement.

Activity-Specific Assessments

- Activity 2: Students will measure the mass and volume of a given object, picking the correct tools to do each measurement.
- Activity 3: Students will measure the speed of a toy car rolling down an incline plane at various heights and calculate the speed of the toy car at each height.
- Activity 5: Provide students with samples of saltwater or sugar water and ask them to describe how they would separate the salt or sugar from the water based on their observations of the water cycle. Students should design and complete an experiment to separate a saltwater or sugar water solution.

Resources

Books:

- Myller, Rolf. *How Big Is a Foot?* New York: Atheneum, 1962.

Internet sites:

- <http://www.montana.edu/wwwet/journey.html> - The Incredible Journey Water Cycle Game

Teacher Resources:

- Ardley, Neil. *The Science Book of Hot and Cold*. New York: Harcourt Brace Jovanovich, 1992.
- VanCleave, Janice. *203 Icy, Freezing, Frosty, Cool and Wild Experiments*. New York: John Wiley and Sons, Inc., 1999.

**Grade 4
Science
Unit 2: Sound, Light, and Heat**

Time Frame: Approximately five weeks



Unit Description

This unit provides opportunities to investigate the properties of light, heat, and sound through a series of hands-on activities.

Student Understandings

The students will understand that sound, light, and heat are separate forms of energy. The students will also understand how energy is produced and transmitted. Through various experiments or inquiries, students will describe how each of these forms of energy is used in everyday life.

Guiding Questions

1. Can students describe how sound is produced?
2. Can students describe how sound changes using the terms *volume* and *pitch*?
3. Can students define and describe white light?
4. Can students define and describe heat?

Unit 2 Grade-Level Expectations (GLEs)

GLE #	GLE Text and Benchmarks
Science as Inquiry	
1.	Ask questions about objects and events in the environment (e.g., plants, rocks, storms) (SI-E-A1)
2.	Pose questions that can be answered by using students' own observations, scientific knowledge, and testable scientific investigations (SI-E-A1)
3.	Use observations to design and conduct simple investigations or experiments to answer testable questions (SI-E-A2)
4.	Predict and anticipate possible outcomes (SI-E-A2)
5.	Identify variables to ensure that only one experimental variable is tested at a time (SI-E-A2)
6.	Use a variety of methods and materials and multiple trials to investigate ideas (observe, measure, accurately record data) (SI-E-A2)
7.	Use the five senses to describe observations (SI-E-A3)
8.	Measure and record length, temperature, mass, volume, and area in both metric and U.S. system units (SI-E-A4)

GLE #	GLE Text and Benchmarks
10.	Express data in a variety of ways by constructing illustrations, graphs, charts, tables, concept maps, and oral and written explanations as appropriate (SI-E-A5) (SI-E-B4)
11.	Combine information, data, and knowledge from one or more of the science content areas to reach a conclusion or make a prediction (SI-E-A5)
12.	Use a variety of appropriate formats to describe procedures and to express ideas about demonstrations or experiments (e.g., drawings, journals, reports, presentations, exhibitions, portfolios) (SI-E-A6)
13.	Identify and use appropriate safety procedures and equipment when conducting investigations (e.g., gloves, goggles, hair ties) (SI-E-A7)
15.	Distinguish between what is known and what is unknown in scientific investigations (SI-E-B1)
18.	Base explanations and logical inferences on scientific knowledge, observations, and scientific evidence. (SI-E-B4)
20.	Determine whether further investigations are needed to draw valid conclusions (SI-E-B6)
Physical Science	
28.	Explain the relationship between volume (amplitude) of sound and energy required to produce the sound (PS-E-C1)
29.	Compare the rates at which sound travels through solids, liquids, and gases (PS-E-C1)
30.	Explain the relationship between frequency (rate of vibration) and pitch (PS-E-C1)
31.	Diagram what happens to white light as it passes through a prism (PS-E-C2)
32.	Describe how light bends or refracts when traveling through various materials (e.g., pencil in a glass of water) (PS-E-C2)
33.	Describe how heat energy moves through a material by conduction (PS-E-C3)
34.	Give examples of ways heat can be generated through friction (e.g., rubbing hands) (PS-E-C3)
35.	Give examples of ways heat can be produced by conversion from other sources of energy (PS-E-C3)
39.	Describe energy transformations (e.g., electricity to light, friction to heat) (PS-E-C6)

Sample Activities

Activity 1: Sound and Vibrations (GLEs: 6, 7, 10, 12, 13, 28)

Materials List: balloons, large and small cans, rubber bands, rice, plastic wrap, ruler, string, metal spoons, pencils, tuning forks, battery operated radio (one for class use), science learning log, teacher selected reading materials on sound and sound production

Safety Note: Have students identify the safety precautions needed when placing fingers to their ears. (Caution students not to stick their fingers into their ear but gently place their fingers on their ear.) Have students identify the safety precautions necessary when working with electrical appliances. (Check for frayed cords before plugging the cord in the wall, do not use wet hands to plug in the cord, and pull from the plug not the cord when removing the cord from the outlet.)

Using a Directed Reading – Thinking Activity *DR-TA* ([view literacy strategy descriptions](#)), hold a class discussion about sound, eliciting from the students what they know about the production of sound. Record student ideas on the board or chart paper. In their science *learning log* ([view literacy strategy descriptions](#)), have students write predictions about how sounds are created. Student pairs should share their predictions and discuss reasoning behind the prediction. Students should check and revise their predictions throughout this unit as they participate in investigations and read teacher selected materials. At the end of this unit, students will use their predictions as a discussion tool and as a guide for writing a unit summary.

A *DR-TA* is an instructional technique that invites students to make predictions, and then check their predictions during and after the reading or investigation. The *DR-TA* provides a frame for self-monitoring because the teacher pauses throughout the reading or investigation to ask students questions.

Part A: To help establish the concept that sound vibrations travel through the air, students should conduct the following activity. In groups have students place a piece of plastic food wrap over the top of the larger can and hold the plastic in place with a rubberband. (This setup will be used again in Part B.) Sprinkle rice on top of the plastic. Students should hold the small can near the rice, tap the small can with the ruler, and observe the rice. Observations should be recorded in their science *learning logs*. Briefly discuss observations and relate the movement of the rice to the vibrating plastic. *Note: The plastic moved because sound energy that was created when the ruler hit the smaller can, traveled through the air and hit the plastic, causing it to vibrate.*

Have students identify the safety precautions needed for this part of the activity. (*Caution students not to stick their fingers into their ear but gently place their fingers on their ear.*) The students will work in cooperative groups to construct and use a sound machine. By attaching a metal spoon with a rubber band to the center of a forty-centimeter length of string, students will have a device that they can use to investigate the

effect of applying varying amounts of force to the spoon and its relation to the volumes of the sound.

Illustration of Sound Machine Set-up

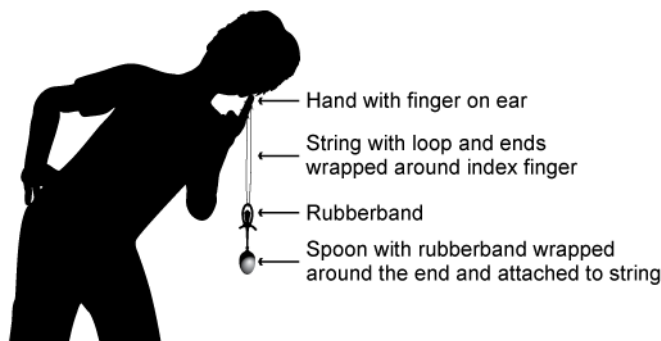

The free ends of the string are wrapped around the student's index finger. The student places the finger to his or her ear, leans over slightly, and allows the spoon to dangle freely. Another student gently strikes the spoon with a pencil. Each student takes a turn. Observations should be recorded in a science *learning log*. Then, the teacher will ask the students to think about how they could make the sound louder. Students should repeat the action but varying the strength of the strike. Students note the volume of the sound each time. Discuss student observations. Introduce the term *volume* and define as the loudness and softness of sound. Reinforce the concept that energy variance will influence the volume by having one member of each group strike softly on cue. (The spoon should be held away from a student's body.) Then, strike with more energy on cue. In their science *learning logs*, students should discuss these differences and how to change volume. Ask the students what was needed for the spoon to create sound. Have group members hold the spoons away from their bodies, strike the spoons, and observe the vibrations.

Part B: A tuning fork is used in this investigation. Demonstrate how a tuning fork works and the correct way to strike it to make it vibrate.

Striking the fork with varying force will illustrate the previously observed principle that adding more energy increases the volume. Students should touch the stem of the vibrating tuning fork to another solid such as the desktop, a wooden meter stick, or a taut string and note the results. To further support the idea that solids are vibrating when sound is created, the students can observe that not only is sound the result of vibration, but causes vibrations, as well. Return to the can and rice setup used in Part A. The tuning fork can be placed against the large can, which has a piece of plastic stretched across the mouth of the can. The plastic is held in place with a rubber band. The students can place rice or tiny pieces of paper on top of the plastic and then touch the vibrating tuning fork to the side of the can to observe the rice/paper move. To illustrate the effect of increasing volume, place the can with the plastic setup next to a radio. Again have students identify the safety precautions necessary when working with electrical appliances, particularly if a battery operated radio is not available. (Check for frayed cords before plugging the cord

into the wall, do not use wet hands to plug in the cord, and pull from the plug not the cord when removing the cord from the outlet.) The students will observe the rate of vibration of the rice/paper when the volume of the radio held nearby is increased and when the proximity of the radio to the can is changed.

Using teacher selected reading materials, have students read about sound and confirm or revise their predictions about how sound is created. Conduct a teacher-facilitated group discussion about sound. The discussion should include that sound is energy, that vibrations produce sound, and that the volume of sound produced is affected by energy transferred through the medium in which the vibrations occur. Have students reflect on their observations and readings and write a summary in their science *learning log* about sounds and how they are created. Also, have them explain in writing how to create loud and soft volumes when striking an object.

Activity 2: Sound in Air, Water, and Solids (GLEs: 2, 6, 12, 13, 18, 29)

Materials List: funnel, rubber hose, basin, water, stethoscope, science learning log, Sound Mock Lab Data Table BLM (Cut out the data tables and give each group one copy), software to create concept maps (optional)

Safety Note: Provide careful directions when preparing the students to use the stethoscopes. Have students identify the safety precautions necessary. (Students should not tap or touch the end! A very loud sound will result.)

Have students recall that sound is created when an object vibrates. Lead them to also recall that they have seen different things vibrate. Ask them what kind of things can be made to vibrate? (Students have only seen solids vibrate at this point in time.) Ask students if there is a something solid between the teacher's mouth and their outer ear that is vibrating? (air) Ask questions that will generate student questioning of how we hear and what forms of matter can carry vibrations. Have students identify which questions they can investigate to determine what types of matter will vibrate.

Part A: Provide students with basins, or large plastic containers, water, and student constructed stethoscopes. (Actual stethoscopes can be used, if available but student constructed ones work well.) To construct the stethoscopes, have students attach a rubber hose to the narrow opening of a funnel.

In this investigation, students will try to transmit sound through a solid (table), a liquid (water), and a gas (air). Using a stethoscope and a basin of water, students will take turns within the cooperative group. One will use the stethoscope while another taps his or her fingers together near the open end of the funnel on the student-constructed stethoscope. Again have students identify the necessary safety precautions when using stethoscopes. (*Students should not tap or touch the end! A very loud sound will result.*) The student should then submerge the end of the stethoscope into the basin of water while the other student submerges his/her fingers and repeats the tapping. Next, the student should place

the end of the stethoscope onto the desk. The other student should gently tap on the opposite end of the desk with his/her finger. Students should switch roles and repeat the activity. In their groups, students discuss and compare the volumes of the sounds as transmitted in the media (desk, water, and air) and then write their observations in their science *learning logs* ([view literacy strategy descriptions](#)). Class discussion should follow.

Part B: Ask students to review the states of matter through which sound can travel. Provide students with a copy of Sound Mock Lab Data Table BLM that shows the results of a mock experiment that tested the speed of sound through different forms of matter. The conclusion should not be filled in on the mock lab sheet.

Substance	Temp (Degrees C)	Speed (m/s)
Steel	20	5960
Air	20	343
Water	20	1482

Based on the results, students should infer through which type of matter sound travels the fastest. Have students brainstorm reasons why the speed is different in the three types of matter. The student should refer back to their previous knowledge of matter and relate the differences in speeds to the closeness of the particles of matter in each state. Refer back to Unit 1 Activity 4, if needed.

To help them visualize the differences in the speed of transmission, students can represent the particles of matter. Students can model the transmission of sound in a solid by standing close together and bumping against one another to pass on the vibration. Having students hold hands and gently pulling each other to represent vibrations can model the liquid state. For sound transmission in a gas, the students could stand far apart in the room and wait for a student (particle) to bump them in order to pass on the vibration.

Again, have students return to their science *learning logs* and confirm or revise their predictions about sounds. Students should also write a conclusion for the mock lab that includes their reasons for the differences in speed. A class discussion should follow. The class may also be asked to include this information in a concept map about sound. Computer software, such as Inspiration© can be used to create a class concept map, if available.

If time permits, have the students research ways in which humans have been able to benefit from the fact that sound travels faster through solid objects than air. For example, hunters would listen for the sound of buffalo running on the plain by placing their ear to the ground or they would listen for an approaching train by “hearing” the vibrations on the solid rail tracks before the train was in view or heard.

Activity 3: Sound Pitch (GLEs: 1, 2, 3, 4, 6, 7, 11, 12, 13, 20, 30)

Materials List: bobby pins, pliers, tape, tuning forks of various pitches, petroleum jelly, clear transparency sheets, straws, scissors, measuring tape, strings, rubber bands of various thicknesses, spring scales, glass bottles, water, pencil, hard plastic ruler, Four Question Strategy Planning Guide BLM (1 per group), Four Question Strategy Planning Guide Answer Sheet BLM, science learning logs

Safety Note: When students plan their investigations, have students identify any safety procedures and equipment necessary for their investigation.

Part A: Prior to the activity, the teacher will use a pair of pliers to straighten the bobby pins. In groups, students are to tape a bobby pin to the tip of a tuning fork, leaving about $\frac{1}{2}$ inch of the bobby pin protruding beyond the end of the fork. Instruct them to smear petroleum jelly on a transparency, strike the low-pitch tuning fork, and hold the bobby pin gently on the transparency. Record observations about sound, vibrations and the marks on the transparency in a science *learning log* ([view literacy strategy descriptions](#)). Repeat the above procedure using the high-pitch tuning fork. Within groups, the students should discuss their observations. Next, hold a class discussion and have students describe and contrast the sounds and patterns made in the petroleum jelly. Lead them to the development of the definition of *pitch* and discuss its relationship to frequency (the length of the mark on in the jelly). Contrast this definition with volume.

Ask students to try to think of what things could affect the pitch of a sound. On a table, have various materials such as straws, scissors, measuring tape, strings of various thicknesses, rubber bands of various thicknesses, and spring scales. As they look at the materials have students think of possible testable questions about how the items might affect the pitch of a sound. Students may ask if the length of the straw or string, if the thickness of the strings or rubberbands, or if the tension on the rubberband or string will affect the pitch.

Using the Four Question Strategy Planning Guide BLM, allow groups to pick a variable that they will test, establish controls and procedures, list materials, and plan on how they will collect and measure data. (The students will likely test tension [spring scales], thickness, and length as variables that effect pitch.) Students should identify any safety procedures and equipment necessary for their investigation. Upon teacher approval of the procedure, have students predict the outcome of their experiment, conduct their investigations, and collect data. Have students determine whether they have sufficient data to draw a conclusion or whether they need to collect more data before drawing a valid conclusion. If they have sufficient data, students should write a conclusion to the investigation. If data is insufficient, then have students plan further investigations.

This activity should be extended with a teacher demonstration as follows: Fill identical glass bottles or other containers with varying amounts of water. Strike each container gently with a pencil. (Varying lengths of aluminum tubes from a wind chime or nails can also be used. Lay the tubes or nails on a piece of foam rubber in random order to make a

xylophone.) Students will listen to the pitch of each glass/tube/nail. Have one group of students at a time come to the front of the class. Ask students to attempt to arrange the glasses/tubes/nails according to the pitch, from highest to lowest. Facilitate a group discussion of the following questions: Which glass/tube/nail has the highest pitch? Which has the lowest? Can you state a hypothesis for the effect you observed?

Part B: Break students into groups and provide each with a hard plastic ruler. Ask them how they could make the ruler vibrate and can the ruler be made to vibrate at different pitches? Then have students create a testable question regarding the metric lengths of the rulers and the pitch. Guide students to design their procedures. *Note: Have all students agree on three lengths to test as it may become difficult for them to hear with so much noise in the classroom.* Have students create a data table in their science *learning logs* and make sure that they include an observation of the vibration speeds in their data table. They should draw the conclusion that the faster the vibration, the higher the pitch.

Return again to the science *learning logs* and confirm or revise predictions about sound. Students should write a final summary about sound and how it is created. Students should share their summaries and results with a student from another group.

Activity 4: Refraction of Light (GLEs: 10, 12, 13, 32)

Materials List: clear bowl or tank or clear plastic cup, water, clear glasses, pencils, ruler, hand lenses, plastic bread twist ties or bare copper wire, safety goggles, battery lighted microscope (optional), science learning logs

Safety Note: Have students identify safety precautions needed when working with glass. (Wear safety goggles and check for cracks or chips)

Working in groups, students will place a pencil marked with given measurements (9 cm, 12 cm, 15 cm) in a clear glass. The students will observe the pencil and draw a diagram of the image in their science *learning logs* ([view literacy strategy descriptions](#)). Have students pour water in the glass until it reaches the 9 cm mark. Have students make observations, noting how the pencil appears to bend or break at the waterline, and write an initial explanation of why they think the object looks this way in their science *learning logs*. The students will slowly pour more water into the glass to the 12 cm mark and draw a diagram of the pencil. Repeat filling the glass to the 15 cm mark. Each student will continue to record the observations in his or her science *learning log*. The teacher will facilitate a group discussion about why the pencil looks bent. Explain that the bending (refraction) of light through water causes the pencil to appear bent. Guide students through questioning to define *refraction* based on their investigation. Have students note the bending of the light at the interfaces (the meeting place of two different media). This should facilitate a discussion about the speed of light in different types of matter.

The students will then dip a wire lens made from the stripped twist tie or bare copper wire that has a 2 cm loop twisted at its top, into the water.

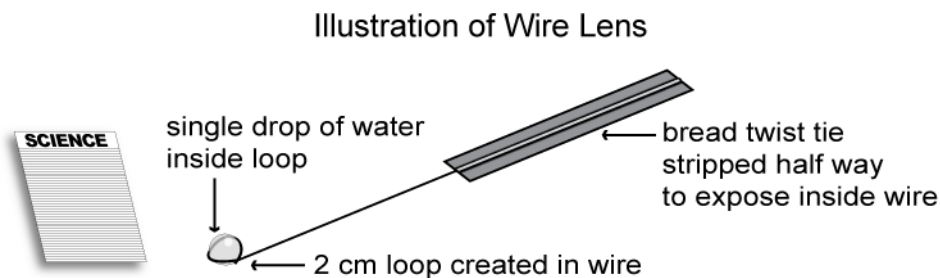

After removing the wire loop with a drop of water in the loop, students should observe how light is refracted through this lens as they try to read print. Have the students explain why the light is being refracted. The students will then be given hand lenses to make other observations of refraction. (If battery lighted microscopes are available, a small piece of newsprint can be placed on the stage, and students can observe how the lens of the microscope affects the image.)

Fill a water tank or large clear bowl with water. Students will observe refraction in the tank or bowl as they try to touch a submerged object. (The object isn't where it appears to be located as seen from above.) Have students refer back to the previous discussion about the speed of light changing at the interfaces that resulted in the bending of light. Have one student place a penny in the tank and have one student stand so that he is looking into the tank from above. Have the student looking into the tank from above put a ruler in the water where the object appears to be and have another student, looking into the tank at eye level, actually locate the object with another ruler. Have the students contrast the distances between the rulers and explain the reason for the difference.

In their science *learning logs*, have students summarize how light changes as it passes through different mediums.

Activity 5: Separating Light (GLEs: 6, 10, 12, 31)

Materials list: one small box per group, different colored strips of paper, black paper, scissors, tape, glue, aluminum loaf pan, water, strong flashlights, small mirrors, prisms, white paper, crayons, **teacher selected resources explaining rainbow formation**, science learning log

Part A: Prepare a box by taping squares of different colored paper to one side of the inside of the box. Cut a small eyehole in the side of the box that is opposite the colored paper. (See Figure A) Cut strips out of the top of the box and cover by taping black paper over the openings. (See Figure B) Place the lid back on top of the box and tape it in place.

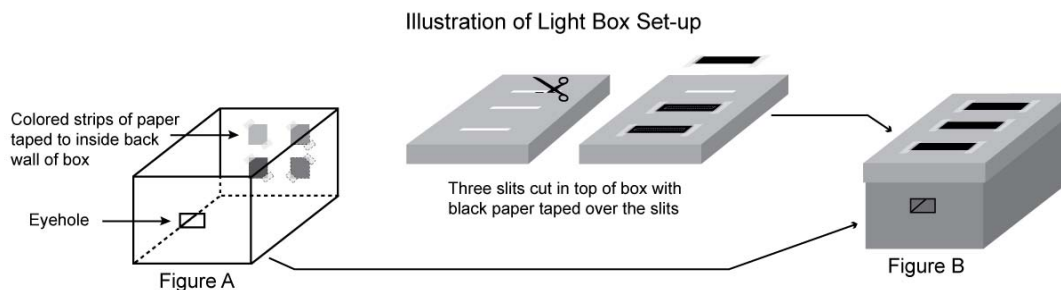

(Students need to have a working definition of *reflection* and *refraction*.) Ask students where colors come from, as light appears to be white.

To establish that colors are part of white light, have students observe the pieces of colored paper through a small cut hole located on the opposite side of the box. Gradually open cut strips at the top of the box to allow light in. Ask the students what conditions have to be present for them to see color. What colors do they see outside at night?

Part B: Have students think about the colors that they have seen in the sky. They may refer to blue skies, black skies during rain and at night. Prompt them to think of a time when they saw more colors than those. (Rainbow) Have them recall the weather conditions preceding and those present during the formation of the rainbow. This will establish that water droplets and the Sun are both necessary to see a rainbow.

Provide students with aluminum loaf pans, water, a sheet of white paper, and a flashlight. (Teacher note: Some flashlights work better than others, so make sure to test the flashlight before starting this activity.) With little instruction, allow them to attempt to create a rainbow. They will observe reflection of the light off the bottom of the pan, but not the rainbow. Next, provide a mirror for students to place in the pan. They should manipulate the mirror and the beam of light until they create a rainbow on the white sheet of paper. The students should then analyze the location of the beam of light from the flashlight relative to the water. They should also realize that both reflection and refraction are occurring to create the rainbow behind and above the flashlight. The students will draw the path of the light and the rainbow in their science *learning logs* ([view literacy strategy descriptions](#)). Using other resources, they will research how rainbows are formed and write a summary below their drawing.

Part C: The teacher should introduce the term and the definition of the *visible spectrum*. In order to help the student to understand further that white light is composed of all colors of the visible spectrum, the teacher will pass out prisms, strong flashlights, and a piece of white paper to student groups. Provide a demonstration of how to use a light source and a prism to separate light into color bands. Students should position the prism so that it casts a rainbow on the white paper. (This activity can also be done outside on a sunny day. The students can use the Sun as the light source and the prism to separate the light into color bands.) Instruct students to draw this in their science *learning logs* and label the

order of the color bands. They should be guided with questioning to draw and label the bending of the light at the interfaces of the prism and the air. Have them relate this bending to the refraction activities in Activity 4 and to the creation of the rainbow in the earlier part of this activity.

Activity 6: Heat (GLEs: 1, 2, 10, 11, 12, 13, 15, 34, 35, 39)

Materials list: non-mercury thermometers, safety goggles, 30 cm section of wire per student, string, science learning log

Safety Note: Safety goggles should be worn to protect the eyes when bending a wire.

Ask, “What is heat?” In pairs, have students list all possible causes of heat. Share ideas and discuss. Have students create a KWL *graphic organizer* ([view literacy strategy descriptions](#)) in their science *learning log* ([view literacy strategy descriptions](#)) and record what they know about heat and what they want to know about heat. At the end of the activity, students will record the answers to what they wanted to know about heat under L and anything else that they learned about heat. For example,

K	W	L
The Sun gives off heat.	How is heat created?	
Mom uses heat to cook food.	How does heat from a stove warm my food?	

Be prepared to provide additional resources to students whose questions listed under Want to Know were not answered.

Previously, students have learned that light can be a source of color. Ask students to think of other benefits from light energy provided by the Sun. Have them think about their previous knowledge of the former planet Pluto. How would they dress if they lived on Pluto? (They would need warm clothing.) Have them explain their reasoning. Ask them what is providing the heat on Earth. Guide students to explain that sunlight can be transformed into heat energy. Challenge them to prove that Sunlight can be transformed into heat energy by designing an investigation. Accept all reasonable plans for experimentation. These may include such suggestions as measuring the temperature of an outside wall at different times during the day or constructing a solar oven. Once their investigation topic has been approved by the teacher, students should be provided with ample time to test their idea. They should identify what is known and what is unknown in their investigation, and record their observations in tables in their science *learning logs*. Use guiding questions to assist students in reaching the conclusion that light energy can be transformed into heat energy.

Next, ask the students if sunlight is the only means of creating heat energy. The students will use the following activity to discover the effects of friction in heat generation. The

teacher will instruct students to rub their hands together rapidly. Students should record their observation in their science *learning log*. Class discussion should follow emphasizing the resultant heat.

Inform the students that they will be bending a wire. Ask students what safety precautions and equipment they will need to protect their eyes. (*Safety goggles should be worn.*) Instruct students to bend a 30 cm section of wire back and forth about six times and then feel the bend in the wire. Next, have students rub a taut length of string over the edge of their desk and feel the string. Have students record their results for each investigation in their science *learning logs*. Ask students to explain the commonalities in each activity that may be the cause of the creation of heat. The students should conclude that in each case an object was moving against another object or section of itself. As a class operationally define *friction* as a force that generates heat. Explain that friction is the force acting on two objects when they rub against each other. Have students list real-world examples of friction (brakes on a car, rolling ball stopping, etc.).

Guide students with questioning to the concept that energy can also be produced from burning matter. Lead students to understand that this is a conversion from the chemical energy that is stored in matter to heat energy and light energy. Return to the KWL *graphic organizer* and add any new information learned.

Students should write a brief paragraph defining and describing what they have learned about how heat can be produced by conversion from other sources of energy.

Activity 7: Conduction and Conductors (GLEs: 1, 2, 3, 4, 5, 8, 10, 11, 33)

Materials list: pieces of paper, non-mercury thermometers, stopwatches, resealable plastic bags, tape, plastic containers, cold and warm water, solid vegetable shortening, variety of materials to be tested as conductors and insulators

Remind students that their own bodies produce heat as the chemicals in foods they eat are broken down and used to power the body. Have them place one palm against a piece of paper and feel the paper's temperature. Then have them place their other palm against their hand on the opposing side of the paper. Has the temperature changed? How did this happen? (Students will likely say that the heat from their hand passed through the paper. Ask, what is similar between this passing of heat through the paper and when friction generates heat? (Both required contact between surfaces.) Using their previous experiences and observations ask students to define *conduction*. Demonstrate and explain, if needed, to provide clarity. The students will describe conduction as a transfer of heat energy that requires two objects to touch. Ask students to compare this with the heating effect of the Sun.

Provide time for a discussion and diagram of radiant heat transfer. Ask students how they can prove that for heat conduction to take place, the objects need to be in contact with each other. Allow the students to test their theories. Ask students to start to think about

materials that hold in heat and those that allow heat to pass through them easily. Guide the class to define *conductors* and *insulators*. Based on their experiences, have student work in discussion groups to predict materials that they think may be conductors or insulators of heat.

Using their lists of materials which they have predicted as conductors or insulators, the teacher will provide a number of objects that the students can test. The students will need a supply of non-mercury thermometers and stopwatches for the activity. Ask students to devise the question that they want to investigate, plus determine both controls and variables for their experiment and to be sure that only one experimental variable is being tested at a time. Students should use their previous experiences and knowledge to predict the outcome of their experiment. One possible investigation is testing whether the material an object is made of affects its ability to conduct or insulate. The students may place their chosen material in a sealable plastic bag, tape a thermometer on top of the material in the bag, fill the bag with air, and seal the bag. Next, the student could float the bag in a tub of cold or warm water, noting the temperature of the water, the temperature shown on the thermometer in the bag prior to insertion, and the temperature of both in determined time intervals after insertion. Other suggestions for possible investigations made by students should be considered.

Students should record temperature in both metric and U.S. system units. The results would be recorded in a table and graphed. Students would present their findings to the class and make a recommendation for the usage of the material in building a home or in wearing materials during different seasons.

If time permits, a life science guided exploration could be conducted by students to investigate how skin and varying amounts of blubber affect heat transfer. Using doubled bagged sealable plastic bags and solid vegetable shortening, the student will model various animal adaptations. In each test, double bags are used to represent the skin and the muscle. Empty bags represent the skin without blubber. Bags having a thin one cm of shortening placed between the walls of the outer and inner bag represent animals having low body fat. Bags, having two cm of shortening between the walls of the outer and inner bags, represent animals having thicker body fat. After creating the models, ask students to design the procedures and to identify the controls and variables, being sure that only one experimental variable is being tested at one time. The students could devise a test to determine how body fat affects the ability to insulate or conduct heat by measuring the air temperature within the bags (metric and U.S. system units) before and after insertion into the ice water. (Body fat or blubber in marine animals provides insulation against the cold by keeping in the body's heat and keeping out the cold.) They would measure temperature of the water and the air in the bags at various intervals, record the data in a student constructed data table, and graph the results. Then, they could write their conclusions as to the benefit of body fat in land animals and marine animals.

Activity 8: Concept Review (GLEs: 28, 29, 30, 31, 32, 33, 34, 35, 39)

Materials List: Energy Word Grid BLM (1 per student)

To review unit content, on the board or overhead projector create a *word grid* ([view literacy strategy descriptions](#)) with the students, focusing on heat, light, and sound. Provide each student with a copy of the Energy Word Grid BLM. A *word grid* provides students with an organized framework for learning related terms through analysis of their similarities and differences. They should be co-constructed with the students to maximize participation in the word learning process. To create the *word grid* list the words *light*, *heat*, and *sound* as headers for the rows. Then guide students through discussion to list attributes of light, heat, and sound as column headers. Through guided discussion have students answer yes/no to each attribute for each word. Once completed, have students write compare/contrast sentences for the three forms of energy discussed using the *word grid*. Also allow time for students to quiz each other over the content of the grid in preparation for tests and other class activities.

Sample Energy Word Grid

	Is a form of energy?	Can be refracted?	Can travel through solids?	Can be conducted?	ETC.
SOUND	yes	yes	yes	yes	
LIGHT	yes	yes	no	no	
HEAT	yes	no	yes	yes	

Sample Assessments**General Guidelines**

Assessment techniques should include use of drawings/illustrations/models, laboratory investigations with reports, laboratory practicals (problem-solving and performance-based assessments), group discussion and science *learning logs* (reflective assessment), and paper-and-pencil tests (traditional summative assessments).

- Students should be monitored throughout the work on all activities via teacher observation of their work and lab notebook entries.
- All student-developed products should be evaluated as the unit continues.
- For some multiple-choice items on written tests, ask students to write a justification for their chosen response.

General Assessments

- The student will keep a science *learning log* of investigations and new and relevant vocabulary that will be checked after each investigation.
- The student will explain in writing how the sounds of wind chimes or a large bass drum are made and why they vary.
- The student will write a paragraph about how heat is conducted and explain which types of materials conduct heat the best.

Activity-Specific Assessments

- Activity 3: Shown a picture of three identical bottles with various levels of water, the students will infer which would have the highest pitch when struck with a tuning fork or drum stick, etc. Shown a picture of three strings of various thicknesses, the student will infer which has the highest pitch when plucked.
- Activity 4: The student will draw what a pencil looks like in a partially filled glass of water, as viewed from the side. The student will identify this drawing as an example of refraction and explain why refraction occurs.
- Activity 5: The student will draw the effect of light traveling through a prism and explain why the light is bending. They will also identify this bending as refraction.

Resources

Teacher Resources:

- Ardley, Neil. *The Science Book of Hot and Cold*. New York: Harcourt Brace Jovanovich, 1992.
- DiSpezio, Michael. *Awesome Experiments in Light and Sound*. New York: Sterling Publishing Co., Inc., 1999.
- Wood, Robert W. *Physics for Kids, 49 Easy Experiments with Optics*. Blue Ridge Summit, PA: TAB BOOKS, 1990.
- Wood, Robert. *Heat Fundamentals Funtastic Science Experiments for Kids*. Philadelphia: Chelsea House Publishers, 1999.

Internet Sites:

- <http://library.thinkquest.org/19537/Physics4.html?tqskip1=1> - information on the physics of sound and a Doppler Applet, where the effect of sound produced by a plane traveling at or above the speed of sound can be seen
- <http://www.exploratorium.edu/spectroscope> - directions for building a spectroscope
- <http://sciencenetlinks.com/lessons.cfm?BenchmarkID=4&DocID=330> - a lesson plan that gives students a general idea of how heat is produced from human-based activities and mechanical and electrical machines

**Grade 4
Science
Unit 3: Electricity**

Time Frame: Approximately two weeks



Unit Description

This unit explores some of the elementary concepts of electricity including circuitry, electromagnetism, conductors, and insulators.

Student Understandings

Students will develop an understanding of conduction and be able to classify materials as conductors or insulators and identify types of energy transformations. The students will construct and diagram an electric circuit.

Guiding Questions

1. Can students explain the elements required to make a light bulb work?
2. Can students demonstrate how to construct a complete circuit in order to conduct electricity?
3. Can students explain how a diagram can represent the flow of electricity?

Unit 3 Grade-Level Expectations (GLEs)

GLE #	GLE Text and Benchmarks
Science as Inquiry	
2.	Pose questions that can be answered by using students' own observations, scientific knowledge, and testable scientific investigations (SI-E-A1)
3.	Use observations to design and conduct simple investigations or experiments to answer testable questions (SI-E-A2)
6.	Use a variety of methods and materials and multiple trials to investigate ideas (observe, measure, accurately record data) (SI-E-A2)
8.	Measure and record length, temperature, mass, volume, and area in both metric system and U.S. systems units (SI-E-A4)
9.	Select and use developmentally appropriate equipment and tools (e.g., magnifying lenses, microscopes, graduated cylinders) and units of measurement to observe and collect data.
12.	Use a variety of appropriate formats to describe procedures and to express ideas about demonstrations or experiments (e.g., drawings, journals, reports, presentations, exhibitions, portfolios) (SI-E-A6)

GLE #	GLE Text and Benchmarks
13.	Identify and use appropriate safety procedures and equipment when conducting investigations (e.g., gloves, goggles, hair ties) (SI-E-A7)
21.	Use evidence from previous investigations to ask additional questions and to initiate further explorations (SI-E-B6)
22.	Explain and give examples of how scientific discoveries have affected society (SI-E-B6)
Physical Science	
27.	Describe how the amount of force needed to cause an object to change its motion depends on the mass of the object (PS-E-B4)
33.	Describe how heat energy moves through a material by conduction (PS-E-C3)
34.	Give examples of ways heat can be generated through friction (PS-E-C3)
35.	Give examples of ways heat can be produced by conversion from other sources of energy (PS-E-C3)
36.	Test and classify materials as <i>conductors</i> and <i>insulators</i> of electricity (PS-E-C4)
37.	Demonstrate how a complete circuit is needed for conducting electricity (PS-E-C4)
39.	Describe energy transformations (e.g., electricity to light, friction to heat) (PS-E-C6)

Sample Activities

Activity 1: Electricity Basics (GLEs: 2, 12, 13, 36, 37, 39)

Materials List: flashlight bulbs, insulated wires, D-cell batteries, flashlights, electrical tape, aluminum foil, paper clips, cotton string, pennies, plastic straws, cut rubber bands, polystyrene foam, light bulb holders, science learning logs

Safety Note: Have students identify the safety issues to be considered when working with electricity. Students should wear safety goggles in case the bulbs break or explode. In order to avoid a burn, students should be allowed to tape the wire to the bottom of the battery and should be cautioned about holding the wire only where the insulation is found.

Teacher Note: Please review each part of this activity to determine the amount of time that will be required.

Part A: Have students create a KWL *graphic organizer* ([view literacy strategy descriptions](#)) in their notebooks and record what they know about electricity and flashlights and what they want to know about electricity and flashlights. At the end of the activity, students will record the answers to what they wanted to know about electricity and flashlights under L and anything else that they learned about electricity and flashlights. For example,

K	W	L
The TV needs electricity to work. Flashlights can be turned on and off.	How does electricity travel?	

Be prepared to provide additional resources to students whose questions listed under Want to Know were not answered.

Students, working in cooperative groups, will attempt to light a flashlight bulb using only two insulated wires, a D-cell battery, and a bulb. Distribute intact flashlights and allow students to first look at how a flashlight is designed. Ask them to identify the type of material found on the sides and at the bottom of the flashlight. Instruct students to use only one battery and the wire to light the bulb. Allow students to discover how to create a circuit. Using the learning cycle approach, allow this work to be the students' own with little direction. All models attempted should be drawn in the students' science *learning log* ([view literacy strategy descriptions](#)). After a period of time, if any student group seems to be unable to devise a workable plan, within that group introduce the idea of a complete circuit. Allow students to return to their task. After a period of time (which may vary from class to class), groups may share their outcomes. If any group has not accomplished the task, allow further time to try what they have seen from the other groups.

Introduce and instruct students to create *vocabulary cards* ([view literacy strategy descriptions](#)) using the following vocabulary terms: *electric cell*, *electric current*, *circuit*, *conductor*, *resistor*, *switch*, and *insulator*. In pairs, have students share their vocabulary cards. Hold a class discussion of the words. The vocabulary cards can be used later as a study aid for quizzes and tests.

Vocabulary cards help students see connections between words, examples of the word, and the critical attributes associated with the word and with their understanding of word meanings and key concepts by relating what they do not know with familiar concepts.

Example Vocabulary Card

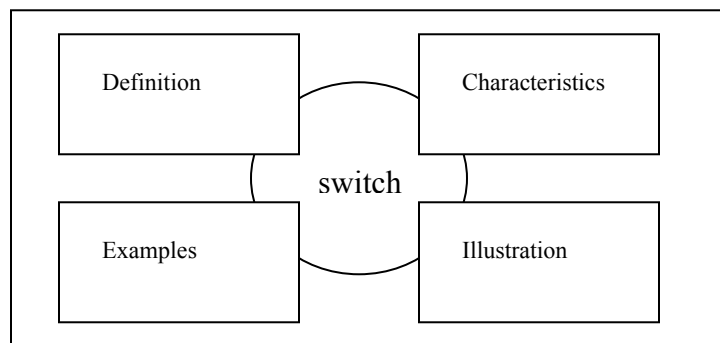

Have students decide which materials from the above activity were the insulator, the conductor, and the electric cell. Have them discuss the role of each in their flashlight design. Students whose first attempt did not cause the bulb to light should explain why. (The circuit was not closed.) They will also relate the creation of a circuit to that of the design of a real flashlight. Through guided questioning, students will infer how the switch works.

To help students understand the role of the electric cell, challenge students to find a way to make the bulb shine brighter and allow students to use more batteries. (*Note: Use no more than three batteries because four batteries may burn up the resistors. The resistor is the filament that glows in the light bulb.*)

Safety Note: Be sure to instruct students to use electrical tape to attach the material to the battery and caution them to avoid touching the wire where it is not insulated. Electrical tape should be on hand to aid in touching the material that will conduct electricity.

Part B: Review the terms conductor and insulator. Using their model circuit, students should begin to think about what materials allowed the electricity to flow and which prevented it from flowing: i.e., plastic, wood, and glass. Distribute a bag of materials to each student group (aluminum foil, paper clips, cotton string, pennies, plastic straws, cut rubber bands, polystyrene foam, and other items). In their science *learning logs*, have students predict whether the objects are conductors or insulators by placing them in two groups. Again have students identify safety procedures and equipment that should be used when working with electricity. After predicting, student groups should then test each item to see if their predictions were correct. Students should attach the item to a wire by wrapping the stripped wire end around the item or placing the item between the wire and the battery. Students should try to light their bulbs and check their findings against the group's original classification. Students will share their results and draw conclusions. The teacher may wish to discuss how insulation prevents fires and contributes to electrical safety in homes, in addition to providing safety tips about placing wires under rugs and using electrical devices near water. Water can then be added to their list as a conductor.

Part C: Facilitate a discussion about the transformation of electrical and chemical energies to light energy. Ask the students if they can explain the source of the light bulbs energy. Discuss the form of energy that is stored in the battery. Elicit what the students know about the chemical makeup of a battery. Have students create their own illustrations to represent chemical energy in the battery transforming to electrical energy and moving through the wire, to heat energy, and then to light energy (when the resistor glows).

This discussion should lead the students to consider why the movement of particles creates heat in the wire and the resistor.

Return to the KWL *graphic organizer* and add any new information learned.

Activity 2: Heat from Electricity (Conduction/ Friction) (GLEs: 2, 3, 12, 21, 33, 34, 35, 39)

Materials List: pencil erasers, metal spoons, non-mercury thermometers, warm water, cups, thin pot holders or tongs, model of inside of light bulb, flashlights, science learning logs

At this point, students may be curious as to why the wires in the circuits heat up. Have them rub an eraser across their desk in the form of an imaginary circuit. Have them feel the eraser and note the heat created by friction. This is a model of the flow of particles on the wire. Have students note that when there is movement, and the ensuing friction caused by the contact of matter against matter, there will be a conversion of kinetic energy into thermal energy. Have students relate this to examples in their lives (e.g., the heat on their bicycle tires when stopping quickly, brush burns on their skin, rubbing their hands together). Emphasize that the heat energy is transferred from one material to another through contact (conduction).

Guide student groups to assist in designing an investigation that will (a) prove that heat is transferred through touch (conduction) and (b) answer their question of why the wire heats up in a circuit. One example experiment is for students to use a metal spoon (representing the wire in a light bulb) that has a thermometer taped to the handle. Students will find and record the temperature of warm water in a cup and that of the spoon. Then students will place only the bowl of the spoon in the water. The spoon will need to be held by thin pot holder or tongs to avoid recording of the warmth of the student's hand. Instruct students to record the change in temperature observed on the spoon's thermometer, explain how the spoon's temperature changed, and relate the change to particle movement in the water, friction, and conduction.

Transformation of energy can now be demonstrated and discussed further. The student should relate the investigation to the resistor in the bulb. A model of the inside of the light bulb should be constructed by the teacher prior to class for the students to observe. This can be done as follows: carefully break away the glass from a full-sized light bulb. Use a cardboard cut out to insert the base into and tape the filament onto it. Otherwise, the filament is too fragile and just flops over, but taped upright onto cardboard, it makes a good visual that can be handled. Also, be sure to tape all exposed edges of the metal base. A large diagram or transparency may also serve as a model. Lead the class in a discussion, using questions such as the following: When one end of a metal object is exposed to heat, what happens to the other end? Can you explain why kitchen utensils (pots, pans) are often made of metal? A light bulb provides light, but what else is created at the same time? (heat) Students can turn on their flashlights and feel the heat created by holding their hand just above the light source.

Refer back to the challenge activity where the students had to make the light bulb shine brighter. Using the above information and guiding questions, lead the students to infer how adding more batteries made the light bulb shine brighter. (The more batteries that are connected, the more electric charge (electricity) that is flowing through the circuit.

The greater the energy, the more resistance the resistor has, and the more heat that is produced in the resistor—therefore, the brighter the light.)

Have the students create an illustration in their science *learning logs* ([view literacy strategy descriptions](#)) that helps them to recall the role of friction and conduction in creating heat and light energies in a light bulb and circuit.

Return to the KWL *graphic organizer* ([view literacy strategy descriptions](#)) and add any new information learned.

Activity 3: Electromagnet (GLE: 6, 8, 9, 12, 27)

Materials List: 1 meter of 18-gauge insulated wire, 6-volt battery, long iron nail, paper clips, wire strippers, balance beam, science learning logs

Safety note: Keeping the current flowing through an electromagnet for a long period of time may cause the nail and wires to get hot. Simply disconnect from the battery and let it cool.

Briefly review magnets and how they work. Have students use the provided materials to construct an electromagnet as follows (refer to the website http://www.msncucleus.org/membership/html/k-6/as/technology/4/ast4_5d.html for a graphic demonstrating the correct set up of the electromagnet). Wrap the wire around the nail about five times, leaving about 15 cm of free wire on each end. Strip (teacher only) about 3 cm of the insulation off both ends of the wire, using the wire strippers. Secure one end of the wire to one pole of the battery. Scatter some paper clips on the table. Hold the nail over the paper clips. Touch the paper clips with the nail. Have students record observations in their science *learning logs* ([view literacy strategy descriptions](#)). While holding the nail close to the paper clip, touch the free end of the wire to the other battery pole. Touch the paper clips with the nail and lift the nail. Record all observations in science *learning logs*.

Have students identify the equipment needed to measure mass and the unit of measurement for mass. Have students mass the paper clips the electromagnet picked up. While holding up the nail with the paper clips on it, remove the wire end from the battery. Record observations. Wrap the wire 5 more times around the nail, hold the nail on the paper clips, and touch the free end of the wire to the battery. Lift the nail and record observations. Have students mass the paper clips the electromagnet picked up. Wrap the wire 5 more times and repeat the above procedure. Have students mass the paper clips the electromagnet picked up. Have a class discussion about the activity. Lead students to explain how the number of wraps around the nail affected the number of paper clips (and mass) the electromagnet picked up. (*The more times the wire was wrapped the more paper clips [mass] the electromagnet [force] picked up.*) Guide students to conclude that by increasing the number of wraps around the nail, the amount

of energy in the electromagnet had increased. Students should also conclude that the greater the mass of the object, the greater the amount of force needed to move the object.

Activity 4: Electricity’s Role in the Modern World (GLE: 22)

Materials List: magazines (optional), poster board, trade books (optional), computer with Internet access

Students will make a list of the appliances, tools, and other electrical equipment that may be found in their homes and neighborhoods. They may also cut out pictures of electrical devices from magazines and create a wall display. Students will share their lists and then contrast the modern age to that of earlier periods. Ideas about earlier times can be found in trade books and films clips. Examples include *Souder*, *Huck Finn*, the *Little House on the Prairie* series, encyclopedias, and visits to local Louisiana historic sites. The students can compare and contrast how people met their needs, did chores, gathered information, communicated with each other, created light at night during periods prior to the availability of electricity and that of modern times. Then, students may report on the uses and importance of electricity in their lives, reflecting on how electrical devices have influenced society. Students can also illustrate these concepts using concept maps and can draw examples of how people lived without electricity. For example, they could draw a candle to contrast with an electrical lamp, a book to contrast with a computer, etc.

Sample Assessments

General Guidelines

Assessment techniques should include use of drawings/illustrations/models, laboratory investigations with reports, laboratory practicals (problem-solving and performance-based assessments), group discussion and science *learning log* (reflective assessment), and paper-and-pencil tests (traditional summative assessments).

- Students should be monitored throughout the work on all activities via teacher observation of their work and lab notebook entries.
- All student-developed products should be evaluated as the unit continues.
- For some multiple-choice items on written tests, ask students to write a justification for their chosen response.

General Assessments

- The student will complete a drawing of a series circuit and label the parts.
- The student will record the circuits designed as drawings.

- The student will illustrate knowledge using roundhouse diagram, concept maps, or other visual representations.
- The student will match illustrations of modern uses of electricity with historic devices that were non-electric.

Activity-Specific Assessments

- Activity 1, Part A: Given a drawing of a circuit, the student will analyze the drawing to determine if a circuit is open or closed and if a light bulb would light. The student will explain why the resistor is needed.
- Activity 2, Part B: Given a list of materials, the students will identify the items as insulators or conductors and will explain how they would test the material to prove them as such.
- Activity 4: The student will report on the uses of electricity and how technology has changed society. Assess the students' reports to ensure they compared and contrasted life with and without electricity.

Resources

Internet Sites:

- <http://www.eia.doe.gov/kids/energyfacts/sources/electricity.html> - provides information on electricity
- <http://www.pbs.org/wgbh/aso/tryit/tech/#> - contains a technology timeline that students can explore to learn how electrical appliances have changed during each decade of this century
- http://www.msncucleus.org/membership/html/k-6/as/technology/4/ast4_5d.html - basic diagram of an electromagnet

Teacher Resources:

- Wood, Robert W. *Light Fundamentals*. Philadelphia: Chelsea House Publishers, 1999.
- *ZAP! Thinkin' Science Series CD*, Edmark.

Grade 4
Science
Unit 4: Living Organisms

Time Frame: Approximately five weeks



Unit Description

This unit will focus on growing plants from seeds, cuttings, or other plant parts and the role of photosynthesis. Careful records of plant growth, especially measurements, will be kept in a science learning log. Activities will provide an introduction to the life cycle of plants and animals and an introduction to the respiratory and circulatory systems of humans.

Student Understandings

Students will label plants structures and describe their functions. Following observations, students will record data tracking plant growth, and life cycle storybooks will be produced by students. After exploring criteria for classification, students will correctly classify organisms. As students analyze the process of photosynthesis, they will identify locations within plants in which this process occurs and identify both the reactants and products of this process. Students will research the ways in which plants are beneficial to animals. After experimentation on plants, students will identify the parts of a plant from which a new plant can be grown. Students will label the organs in the human respiratory and circulatory systems and describe their functions.

Guiding Questions

1. Can students explain the role of roots, stems, leaves, flowers, and seeds?
2. Can students sequence the steps in the life cycle of a plant?
3. Can students explain if new plants can only grow from seeds?
4. Can students explain photosynthesis?
5. Can students identify ways in which plants are beneficial to animals?
6. Can students explain the differences between complete and incomplete metamorphosis?
7. Can students describe the functions of the circulatory and respiratory systems?

Unit 4 Grade-Level Expectations (GLEs)

GLE #	GLE Text and Benchmarks
Science as Inquiry	
1.	Ask questions about objects and events in the environment (e.g., plants, rocks, storms) (SI-E-A1)
2.	Pose questions that can be answered by using students' own observations, scientific knowledge, and testable scientific investigations (SI-E-A1)
3.	Use observations to design and conduct simple investigations or experiments to answer testable questions (SI-E-A2)
4.	Predict and anticipate possible outcomes (SI-E-A2)
5.	Identify variables to ensure that only one experimental variable is tested at a time (SI-E-A2)
6.	Use a variety of methods and materials and multiple trials to investigate ideas (observe, measure, accurately record data) (SI-E-A2)
7.	Use the five senses to describe observations (SI-E-A3)
8.	Measure and record length, temperature, mass, volume, and area in both metric system and U.S. system units (SI-E-A4)
9.	Select and use developmentally appropriate equipment and tools (e.g., magnifying lenses, microscopes, graduated cylinders) and units of measurement to observe and collect data (SI-E-A4)
10.	Express data in a variety of ways by constructing illustrations, graphs, charts, tables, concept maps, and oral and written explanations as appropriate (SI-E-A5) (SI-E-B4)
11.	Combine information, data, and knowledge from one or more of the science content areas to reach a conclusion or make a prediction (SI-E-A5)
12.	Use a variety of appropriate formats to describe procedures and to express ideas about demonstrations or experiments (e.g., drawings, journals, reports, presentations, exhibitions, portfolios) (SI-E-A6)
13.	Identify and use appropriate safety procedures and equipment when conducting investigations (e.g., gloves, goggles, hair ties) (SI-E-A7)
14.	Identify questions that need to be explained through further inquiry (SI-E-B1)
16.	Select the best experimental design to answer a given testable questions (SI-E-B2)
17.	Recognize that a variety of tools can be used to examine objects at different degrees of magnification (SI-E-B3)
18.	Base explanations and logical inferences on scientific knowledge, observations, and scientific evidence (SI-E-B4)
19.	Describe procedures and communicate data in a manner that allows others to understand and repeat an investigation or experiment (SI-E-B5)
21.	Use evidence from previous investigations to ask additional questions and to initiate further explorations (SI-E-B6)
Life Science	
40.	Explain the functions of plant structures in relation to their ability to make food through photosynthesis (e.g., roots, leaves, stems, flowers, seeds) (LS-E-A3)

GLE #	GLE Text and Benchmarks
42.	Describe how the organs of the circulatory and respiratory systems function (LS-E-A5)
43.	Explain the primary role of carbohydrates, fats, and proteins in the body (LS-E-A6)
45.	Identify reproductive structures in plants and describe the functions of each (LS-E-B1)
46.	Describe how some plants can be grown from a plant part instead of a seed (LS-E-B1)
47.	Sequence stages in the life cycles of various organisms, including seed plants (LS-E-B1)
48.	Classify examples of plants and animals based on a variety of criteria (LS-E-B2)
49.	Compare similarities and differences between parents and offspring in plants and animals (LS-E-B3)

Sample Activities

Teacher Note: Some of the work for Activity 7 should be started early in the unit. Teachers may also decide to combine Activity 1 with Activity 4, depending upon time and resources.

Activity 1: Here We Grow! Plant Life Cycle (GLEs: 7, 8, 9, 10, 12, 13, 47)

Materials List: large plastic cups, potting soil, water, disposable pie pans, disposable gloves, safety goggles, lima beans, masking tape, rulers, paper towels, loose-leaf paper, artificial light sources (optional), liquid fertilizer, Plant Vocabulary Self-Awareness Chart BLM (1 per student), Lima Bean Growth Data Table BLM (1 per student), science learning logs

Notes: In order for students to see the complete life cycle of a plant, this activity will take a minimum of eight weeks to complete. Continue with the other activities in this unit and the following unit until the eighth week.

Bean seeds that are packaged for planting should be used rather than those packaged for consumption as the latter have a poorer rate of germination. Also be careful not to buy seeds that have been treated with a fungicide or other chemical since the students will be handling the beans.

Have students identify safety procedures or equipment to be used when handling plants. (Wash hands, use disposable gloves, keep hands away from mouth, and identify allergies.)

To review the basic parts of a plant, have students work in pairs to generate a list of the parts of a plant and their functions. Hold a brief class discussion.

To determine students' prior knowledge of plants, use the *vocabulary self-awareness* ([view literacy strategy descriptions](#)) chart. Students should complete the Plant Vocabulary Self-Awareness Chart BLM at the beginning of the unit to assess their prior knowledge of the words. Do not give students definitions or examples at this time. Ask students to rate their understanding of each word with either a "+" (understands well), a "√" (limited understanding or unsure), or a "-" (don't know). Over the course of the readings and exposure to activities, students should return to the chart and add new information to it. The goal is to replace all the check marks and minus signs with a plus sign. Because students continually revisit their vocabulary charts to revise their entries, they have multiple opportunities to practice and extend their growing understanding of key terms related to the topic of plants. At the end of the unit, if students still have checks or minuses, the teacher should be prepared to provide extra instruction for these students.

Example of Vocabulary Self Awareness chart

Word	+	√	-	Example	Definition
photosynthesis					
chlorophyll					

Part A: Section Overview: Over the course of eight weeks, students will plant a lima bean each week and will make detailed observations of their plants as they develop. At the end of the eighth week, students should have a total of 8 lima bean plants ranging in age from one week to eight weeks that will represent the various stages in the plant life cycle. Demonstrate to students how to plant seeds, using small plastic or paper cups as planters. Students should keep observations in their science *learning logs* ([view literacy strategy descriptions](#)), measuring the changes in height in inches and centimeters, illustrating the plant structures observed, and graphing the growth of their plants over time. Students should note that the seed leaves (cotyledons) are yellowish when they first sprout and then turn green. Ask students to recall the color of most plants. Relate the green color to the presence of the pigment chlorophyll. Point out that the appearance of the green color is a sign that the plant is capable of carrying on a process to make its own food.

Procedure: Again have students identify safety procedures or equipment to be used when handling plants. Separate students into 3 to 4 groups. Each group will receive one large plastic cup, potting soil, water, pie pan, three lima beans, and masking tape. Instruct students to put 5 inches of soil in the cup. Next have each group plant the lima beans about 2.5 cm (1 inch) deep and cover the bean with soil. Students should place their cup in a pie pan and slowly pour water over the surface of the soil. Place a strip of masking tape on the cup and label it with the date of planting. Place the cup in a warm area of the classroom (above 65° F). Artificial light may be used if access to a sunny window is not available. Students should water their plant as needed to keep the soil moist but not

soaked. Students should be told that the soil needs to be warm for the seeds to germinate and that while sunlight is not necessary for germination, once the seed leaves appear then sunlight (or artificial light) is critical for the plant to be able to make its own food.

Instruct students to select the tools and units for measuring height and each day to record observations (plant size in inches and centimeters, color and number of leaves, flowers, or seed pods) of their plants on their Lima Bean Growth Data Table BLM. (Weekly, a controlled amount of liquid fertilizer will need to be applied by the teacher to the plants to ensure optimal growth). When the plants are about 1 inch tall, thin the plants to one plant per cup. Exactly one week later, repeat the above process with three new lima beans in a new cup. Continue this process for seven weeks for a total of seven plantings.

On the eighth week, each group should fold a paper towel in fourths, saturate it with water, and place three lima beans on top of the paper towel. Fold and saturate a second paper towel and place it on top of the lima beans. Place the towels in a warm location in the classroom. Wet the paper towels each day to ensure that the seeds germinate. The next week, student groups should gather their plants, germinating seed, and another lima bean seed. After placing the plants in growth order from youngest to oldest, students should draw pictures of the seed, the germinating seed, and all seven plants. Students should also observe the plants carefully and make sure to include all plant parts in their drawings.

Introduce the students to the stages of the life cycle of a flowering plant (seed stage, germination stage, seedling stage, mature stage, flowering stage, fruiting stage, and seed dispersal stage) and have students label their drawings with the appropriate name of the life cycle stage. Discuss each stage and the features of the plant, such as presence of leaves, flowers, etc. at each stage. Have students use their data tables to graph the growth of the plant over the eight weeks. In their groups, have students look for patterns in growth such as growth spurts.

Part B: Separate students into groups of 4 or 8. Have the students develop a science *story chain* ([view literacy strategy descriptions](#)) about the life cycle of the plant. Students are to write the story from the point of view of the plant. The science *story chain* should begin with the seed, end with the plant dying after producing new seeds, and give information about the changes the plant is undergoing at each stage. Give each student one sheet of paper. Each student will write the opening sentence of his/her plant life cycle *story chain*. The students will then pass their paper to the student in their group sitting to their left, and that student writes the next sentence in the story. The paper is again passed to the left and that student writes the third sentence. The paper should be passed to the next student until a sentence has been written about all stages of the life cycle. Students should take turns in their groups reading their story aloud to the group. All group members should be prepared to revise the story if the information was not clear or incorrect. Have students use their story to create a plant life cycle book. Illustrations can be included in their books. Students can share their books with other students in lower grades.

Ask students to recall the nonliving matter used by the plants and where it came from and to think about where that material goes after the plant dies. Introduce the term *decomposers* and explain that *decomposition* is also a step in the life cycle of the plant. Name a few decomposers and have the students add these decomposers to their last drawings in their plant life cycle books, with arrows, indicating that the material is returning to the soil, air, and water. The students should then be asked how that same material can be used by the next generation of plants.

Activity 2: Food Factory! Photosynthesis (GLE: 1, 2, 3, 6, 7, 9, 10, 13, 16, 18, 40)

Materials List: small potted plants with soft leaves, masking tape or aluminum foil, petroleum jelly, hand lens or microscope, resealable plastic bags, disposable gloves, safety goggles, science learning logs

Safety note: Have students identify safety procedures or equipment to be used when handling plants. (Wash hands, use disposable gloves, keep hands away from mouth, and identify allergies.)

Begin the activity by having students *brainstorm* ([view literacy strategy descriptions](#)) a list of things they need to survive. Students should share their list and through discussion of what we cannot live without, narrow the list down to air, water, food, and shelter. Have students *brainstorm* a list of things plants need to survive. Have students share their list and discuss the basic needs of plants. Help students remember the needs of plants with this acronym (LAWNS – Light, Air, Water, Nutrients, Space). Students should compare and contrast the needs of plants and animals through class discussion.

Ask students where their food comes from (grocery store, etc.). Tell students that plants are special because they can make their own food through a process called *photosynthesis*. Explain that photosynthesis is a process where plants combine carbon dioxide and water and in the presence of sunlight, they are able to produce water, oxygen, and sugar. Using these terms, write the photosynthetic word formula on the board. Explain that photosynthesis takes place primarily in the leaves of the plant and that the green pigment chlorophyll helps photosynthesis to take place.

To demonstrate that photosynthesis occurs in the leaves, have students complete the following activity. (Note: if supplies are limited, this may be done as a teacher demonstration.)

Place students in groups and give each group a plant with soft leaves, such as a geranium, to observe. Students should record all observations in their science *learning logs* ([view literacy strategy descriptions](#)). Direct students to place a piece of masking tape or aluminum foil over a small section of one leaf and place the plant in a sunny area of the classroom or under artificial light. In three days, students should remove the masking tape and record their observations. Discuss any changes that occurred in the leaf. (The color should have faded or turned yellow under the tape.) Hold a class discussion to

determine why the leaf changed colors and relate the changing of the colors to the plant's need for sunlight during photosynthesis.

Begin a discussion about ways to show that a plant is conducting photosynthesis. Prompt the students by having them think of what they would expect to see if a person said that he had cooked a meal (Pots on the stove, someone stirring, food served on plates). Next, ask students to consider what they would expect to find produced if a plant was conducting photosynthesis (Water, oxygen, sugar, starch). Ask students to recall the times that they were under a tree and felt drops of water fall on them, but it wasn't raining. Explain that this water came from the tree as a by-product of photosynthesis which is occurring inside the leaf. Ask students to think of questions regarding the water falling off the tree and what is happening inside of the leaf. (Students may wonder how the water got on the outside of the leaf when it is being created inside the leaf.)

Ask the class, "How can we prove that water is released from the plant's leaves during photosynthesis?" One possible experiment is to have student groups place 3 plant leaves in a plastic resealable bag and place in a sunny window or under artificial light. As a control, place an empty resealable bag in the window. Ask students why this was done. The next day, have the students make observations of the bags. Students should see condensation (water) on the bags with leaves. Ask the students where the condensation came from (the leaves).

Allow students to hypothesize how the leaf sets the water free. (They may think that there must be an opening in the leaf.) Explain that if there are holes in the leaf allowing the water to escape, they may be able to plug them up to stop the water from escaping. To determine whether or not there are openings in the leaf, have students smear both sides of a leaf on a potted plant with petroleum jelly and place a clear plastic bag around the leaf, sealing it at the petiole. Explain to students that the *petiole* is the stalk of the leaf that attaches the blade to the stem of the plant. Discuss the role of the petroleum jelly (to plug the holes). Guide students to establish a control (a plant that has uncoated leaves sealed in a plastic bag). Again, allow the bags to sit overnight and have the students make observations of the bags the next day. The students will observe a collection of water in the bag of the uncoated leaves. Relate the formation of the water on the inside of the bags to the release of water (transpiration) from the leaves during photosynthesis.

Introduce the term *stomata* as the opening in the leaves that allows the water to escape. Later students may wish to alternate the side of the leaf that is smeared with the petroleum jelly to explore further which side has the stomata. Allow students to observe the stomata of leaves using a hand lens or microscope, if available. Students should infer that the excess water created as a by-product of photosynthesis could escape from the plant through the stomata. Note: Aquatic plants have stomata on the top of the leaves, while most land plants have stomata on the bottom of the leaf.

Refer the students to the photosynthetic word formula and ask them to consider that if the stomata open to allow extra water out of the plant, what else could be escaping from the plant through the stomata (Oxygen)? Could the stomata open to let something else pass

into the plant? Looking back at the photosynthetic word formula, the student will search for the matter for which they have not accounted (Carbon dioxide). The students should infer that carbon dioxide could enter the plant through the stomata. This provides a junction for a discussion about the interdependence of plants and animals for gas exchanges.

Activity 3: Identifying Seeds and Seed Makers (GLEs: 1, 2, 7, 13, 45, 47, 48)

Materials List: *The Tiny Seed* or other literature, seeds of various sizes, shapes, and colors, hand lenses, paper plate, pictures of broadleaf and needle leaf plants, small plastic bags, disposable gloves, safety goggles, leaf field guides (optional), leaves from trees native to Louisiana, Internet access (optional), science learning logs

Safety note: Have students identify safety procedures or equipment to be used when handling plants. (Wash hands, use disposable gloves, keep hands away from mouth, and identify allergies.)

Before starting the lesson, give the students the following SQPL ([view literacy strategy descriptions](#)) prompt: “Seeds are important to plants.” In pairs, have students discuss the prompt and write two questions related to the statement that they want answered. Questions should address seed appearance, seed production, seed dispersal, seed anatomy, and seed function. Students should share their questions, recording them on chart paper for later use. If the students do not list some key questions, contribute questions to the list. As the students read teacher-selected reading materials, listen to stories and make observations during investigations; questions should be revisited and answered.

Begin with the children’s book *The Tiny Seed*, by Eric Carle or similar literature. After reading the book, ask the students to discuss what kinds of seeds they have seen. Ask them to think of questions that they may have about the appearance of seeds. (They may wonder if all seeds look the same or are the same size.) Ask students to bring in any seeds they can find. Bring in a seed collection, or bird seed mix, that represents a variety of seed shapes and sizes to help the students to understand that diversity exists. It is also important to bring evidence, when possible, of where the seed came from (e.g., inside a fruit, a cone, a seedpod, or a flower head). The students should examine seeds on a paper plate with a hand lens and sort the seeds into categories of their own choosing. Students will explain their reasons for their grouping (classification scheme) of the seeds such as size, shape, or color. The students will select and in their science *learning logs* ([view literacy strategy descriptions](#)), describe an interesting seed and draw it. They will describe the seed to their partners and the class. Place the seeds in small plastic bags for further reference. The class may wish to organize a seed collection.

Using examples of cones and various fruits, introduce the concept that seed producing plants reproduce by either making cones or making flowers. (Teachers may access <http://home.att.net/~velvet-hammer/evolution.html> to locate pictures of seedpods and

cones of the magnolia, the state flower of Louisiana, and other background information.) Introduce the terms *broadleaf* and *needle leaf* trees. Show examples of each type of leaf, using various resources such as posters from the Louisiana Department of Forestry, actual leaves from trees native to Louisiana, and field guides. Have students classify pictures of leaves as broadleaf or needle leaf and record their lists in their science *learning logs*. Using a field guide or other resource, students should classify the pictures based on the plant being a cone-maker or a flower/fruit maker. Explain to students that nuts may be considered a fruit. Students will record their lists in their science *learning log* and compare the list of leaf types to that of cone or flower-maker lists. The students should conclude that needle leaf plants reproduce by making cones.

Revisit the *SQPL* question list and answer any questions related to the above activity. Have students record the questions and answers in their science *learning logs*.

Activity 4: Growing Seeds (GLEs: 2, 3, 5, 6, 8, 11, 13, 14, 19, 21, 40, 47, 49)

Materials List: red beans, water, resealable plastic bags, soil, seeds, large plastic cups, disposable gloves, safety goggles, graduated cylinder, teacher-selected reading materials on parts of a seed, Red Bean Observation Data Table BLM (1 per student), science learning log

Safety note: Have students identify safety procedures or equipment to be used when handling seeds. (Wash hands, use disposable gloves, keep hands away from mouth, and identify allergies.)

Students have seen the appearances of the outside of various seeds. Ask students what questions they may have regarding the inside of the seed. (Students may wonder if all seeds are the same on the inside or where the new plant comes from.) Inform students that they will observe a dry seed, and like good scientists, they will make careful observations and record them in their science *learning logs* ([view literacy strategy descriptions](#)).

Students will observe a dry red bean (or other bean) and record their observations on the Red Bean Observation Data Table BLM. The table should be divided into two columns labeled “Dry Seed” and “Soaked Seed.” They should pay attention to the smell, color, size, texture, and hardness of the bean and record their observations in labeled rows on their table. The students should trace and then label details about the seed at the bottom of their observation page. The students should place their seed in a measured amount of liquid in a re-sealable plastic bag, letting it soak over night. The next day, the students should make the same observations of the soaked seed and compare it to those made of the dry red bean. The soaked bean should be carefully opened to reveal the internal structures of a dicot seed. Define a *dicot* as a plant that has two seed leaves, or cotyledons, and a *monocot* is a plant that has only one seed leaf. The *cotyledons* are leaves within the seed that contain stored food and are usually the first leaves that the seedling will use to carry on photosynthesis. Have students identify the red bean seed as a

dicot or monocot (*dicot*). The students should carefully draw the internal structures and be aided in labeling the structures as *cotyledon*, *seed scar*, *embryo*, and *seed coat*. Using teacher-selected reading materials the students should explain the function of each part of the seed and the student should illustrate, label, and explain the function of the seed parts in his/her science *learning log*.

Teacher Note: Wisconsin Fast Plants[®] (see resource section) go through their life cycle in approximately 6-8 weeks and are an excellent choice to use to observe the life cycle of a plant; however, time adjustments will have to be made in order to incorporate these into this unit. Radish seeds and mung beans (usually found at health food stores) sprout quickly and would be a good alternative if Wisconsin Fast Plants[®] are not available.)

Students should recall their lima bean plants from Activity 1 (which is still ongoing), and have students think of questions that could be answered about what seeds need to germinate and to list them. (All the students should agree that seeds need water to germinate since the seed soaked up water in the last activity, and they should name additional factors that will influence germination.) Guide students to design questions that could be tested in class. Students may think of the following questions. Does the amount of light provided affect germination? Does temperature affect germination? Does the amount of water affect germination? Do seeds need soil to germinate? Groups should choose one of these questions, and design a full inquiry that will answer their question. Allow students to form study groups based on their interests. The students will decide upon their hypothesis, list variables, controls, materials, data logs, and written procedures. Following teacher approval of investigation design, allow students to conduct their experiments, with guidance. The students will analyze the results of their investigation and draw conclusions. They will report the results of their investigations to the class. All students will record the conclusions of each experiment in their science *learning logs*.

As the plants from the activity above mature, have students identify the various parts of the plant and what role each part of the plant has in making the food. Guide students by having them recall that in their seed-sprouting activities the roots grew down towards the ground (geotropism) and the leaves and stem turned up towards the light (phototropism). Students should be able to relate this behavior (phototropism) to the need of the plant to carry out the process of photosynthesis.

Again, have students keep a data log of plant growth in their science *learning log* that includes the date, daily anecdotal observations, and drawings of their plants. Also measure the growth of the seedlings and create a graph of the growth. As the plants mature, the student will identify the adult leaves and contrast them to the seed leaf. The students will explain how the seedling was different from the adult plant. The students will also observe the appearance of the flower buds, define the bud, and discuss the function of the sepal. The blooming flower will be observed and drawn. If the student-grown plants do not flower well, provide flowering plants to the class for observation.

Revisit the *SQPL* ([view literacy strategy descriptions](#)) question list and answer any questions related to the above activity. Have students record the questions and answers in their science *learning logs*.

Activity 5: Reproductive Parts of a Flower (GLEs: 7, 9, 10, 11, 13, 17, 43, 45)

Materials List: safety goggles, disposable gloves, flowers with 4 basic parts, tape, hand lenses, Internet access (optional), teacher-selected research resources on plant pollinators (bee, bat, and hummingbird), science learning logs

Safety Note: Have students identify safety precautions and equipment required when handling plants. They should wear safety glasses and disposable gloves when working with flowers. Students with allergies or asthma should take appropriate precautions when touching flowers that have pollen.

Part A. Introduce seed production as the main function of a flower. Have students identify the safety equipment and procedures needed when working with flowers. Using an available flower that contains the four 4 basic parts—the stamen, pistil, petal, and sepal—have students draw an illustration of a flower. *Note: Many grocery stores and discount centers that sell fresh flowers may donate those that they would normally discard, but be sure to contact them well in advance.* In groups, the students will carefully dissect the flower, create a detailed illustration of each part in their science *learning log* ([view literacy strategy descriptions](#)), and label the illustration of parts as “sepals,” “petals,” “pistil,” and “stamens” with the use of a resource. The students will tape the actual flower part next to their drawing. Ask students what tool could be used to examine the parts of a flower more closely (a hand lens). The students will observe pollen on the stamen using a hand lens and later research its function. They will draw a pollen grain onto the tip of the stamen, or the anther, of their flower illustrations. Ask students to identify which scientific tool could be used to examine the parts of a flower in more detail than a hand lens (a microscope). Dissection or squeezing of the ovary at the base of the pistil will reveal the eggs.

The student will use resources to identify the function of each flower part, the role of pollinators in reproduction, and the function and the role of each structure that is involved in pollination and reproduction.

Ask the students why pollinators visit the plants. The students may have already learned that pollinators are attracted to the plant for the sweet nectar. Have students recall that during photosynthesis the plant makes sugar. Encourage the students to think of a reason why the plant nectar is attractive to animals.

Separate students into 3 groups and assign each group a pollinator to research (e.g., the bee, the bat, or the humming bird) Groups should provide a report on their pollinators, including information such as the pollinator’s role in pollination and how the plants

benefit the animal. For example, bees use the nectar, a carbohydrate, to manufacture honey, which they store to feed the colony. They all also use the protein in the pollen.

Groups should share their finding with the class. Students should conclude that the sugar produced during photosynthesis attracts pollinators and that the pollinators in turn help to pollinate the plants as they move from plant to plant.

Using *SPAWN* writing ([view literacy strategy descriptions](#)), present the students with the following W or What If prompt: “In several states this year, the bee population has dropped dramatically. What would happen if bees would suddenly become extinct?” Allow time for students to reflect upon and write about the prompt and additional class time for discussion of student responses. Student responses may include a decrease in plant pollination, a decrease in fruit production, higher prices for fruit at the store, etc. Ask students if the decrease in bees would stop plant pollination altogether. (No, because there are other means of pollination – wind, bats, hummingbirds, etc.)

Part B: What method does the plant have for dispersion of seeds by animals? Students will be asked to think about what part of the plant contains the seeds (fruit or pods). Students should consider why they should eat fruit (tastes good, energy, food). Ask students if all fruits are sweet. Carbohydrates make up most of the non-water mass of fruits and vegetables. Students should conclude that fruits provide carbohydrates that are needed for energy by both the plant and the animals that eat them. Students should consider why a plant puts forth so much energy to create a fruit that will be eaten by animals, and consider what the plant receives from providing animals with a sweet treat. Help students to consider what happens to the seeds of a plant when an animal swallows the seeds along with the fruit. Students should conclude that the fruit created by the plant helps in seed dispersion. They should also link the production of a sweet fruit to the production of sugar during photosynthesis.

Instruct students to write a conclusion in their science *learning log* which explains how photosynthesis is important to plant reproduction.

Activity 6: Beneficial Plants (GLEs: 43)

Materials List: teacher selected resources on plant benefits, Internet access

Using resources found at http://www.kidshealth.org/kid/stay_healthy/, the students will research the benefits of eating plants to both humans and animals. The students should focus specifically on proteins, carbohydrates, and fats that animals obtain by eating plants and how these nutrients are used in the human body. The students will conclude that protein, carbohydrates, and fats provide energy to carry on life functions. They will also conclude that the components of protein found in plant materials are broken down by the body and used to produce new cells and maintain old cells. Fats are also used to build cells that surround and protect organs such as the heart, lungs, and intestines. The students will record in their reports reasons that other organisms depend on plants.

Using the researched information, students will use *RAFT writing* ([view literacy strategy descriptions](#)) to write letters to their parents from the perspective of a self-selected fruit or vegetable, explaining the benefits of eating foods from plants. Students should select one fruit or vegetable and list ways the fruit or vegetable provides benefits to the consumer. In the letter to their parents, direct students to convince them to eat the fruit or vegetable by explaining how you (the plant) will benefit them. Students may explain how the carbohydrates or fats will provide energy or how the proteins will be used to produce new cells.

RAFT writing provides students with a creative format for demonstrating their understanding of the benefits of eating foods from plant life. *RAFT* stands for Role, Audience, Format, and Topic. The student's role is the selected fruit or vegetable, the audience is the parents, the format is a letter, and the topic is the benefits of eating food from plant life. Allow students to share their letters with a partner.

Revisit the *SQPL* ([view literacy strategy descriptions](#)) question list and answer any questions related to the above activity. Have students record the questions and answers in their science *learning logs* ([view literacy strategy descriptions](#)).

Activity 7: Producing from Plant Parts (GLEs: 1, 2, 3, 4, 10, 13, 45, 46, 49)

Materials List: plant parts (carrot, onion, potato), water, toothpicks, fungi inhibitor (optional), containers for growing plant parts, disposable gloves, safety goggles, science learning log

Safety Note: Have students identify the necessary safety precautions and equipment for handling plants and chemicals. They should wear safety goggles and disposable gloves, not handle fungicide or germicide, and wash their hands after the handling plants.

Ask the students to think about plants that their parents or other family members may have grown. Did the parent always use a seed to grow a new plant? Some students may suggest that they have seen bulbs being planted or pieces of potatoes. Show students a carrot, an onion, and a potato and ask students if it is possible to grow a new plant from these plant parts. Display and define the term *tuber* and *bulb*. Tubers are different types of modified plant structures that are enlarged to store nutrients. They are used by plants to overwinter and regrow the next year and to reproduce. A bulb is an underground vertical shoot that has modified leaves (or thickened leaf bases) that are used as food storage by a plant. A helpful website is www.Botany.com.

Several of these plant parts should be started by students for observation. Students may need to be instructed to place only a small portion of the carrot top and onion in water and to be watchful for the beginning of mold growth. Change water frequently. If necessary, the teacher should apply a fungi inhibitor, obtained from a garden center. Again have students identify the safety precautions needed with chemicals. (*Do not to*

handle or consume the fungicide.) Suspend the onions on top of a cup of water by placing three-four toothpicks through them. Use the same procedure for the carrot top. The portion of the potato that is used must include at least one eye (A potato “eye” is really a bud). Students will be asked to make predictions about what will happen, to record their predictions in the science *learning log* ([view literacy strategy descriptions](#)), and to track the changes in the bulbs, root, and tubers over time. Drawings and recording of anecdotal observations are to be made in their science *learning log*. Students should compare the similarities and differences between the new plant and the parent plant. The students will conclude that some plants can be grown from their underground storage parts.

Activity 8: Producing from Cuttings (GLEs: 4, 11, 13, 14, 46)

Materials List: plants that easily root from leaf cuttings such as Pothos ivy, African violet, coleus, hoya, Christmas cactus, kalanchoe, etc.; soil or sand; water; planting containers; fungicide; disposable gloves; safety goggles; science *learning log*

Safety Note: Have students identify the necessary safety precautions and equipment for handling plants. They should wear safety goggles and disposable gloves, and they should wash their hands after the handling plants.

Now that students understand that some plants can be grown from a seed or grown from the underground storage parts, have them consider what other parts of a plant can be used to produce another plant. Students may inquire as to whether other parts of the plant, such as a leaf, may grow into a full plant. Allow the students to suggest the plant parts from which they would like to try to grow a plant. Students will explore growing plants from cuttings. A variety of cuttings from different plants should be tried in water and/or on top of soil or sand. Observations will be made in their science *learning logs* ([view literacy strategy descriptions](#)). (Remember to place only a small portion of the plant part in water to try to encourage the growth of a root; otherwise, in time the plant part under water will rot and encourage decomposers to attack the otherwise healthy plant. The teacher may choose to apply a fungicide to the water.) The teacher and students may consult a local nursery, www.Botany.com, or the Cooperative Extension Service in locating plants that can be generated from cuttings. This could also be an opportunity to use the services of a parent who has expertise in gardening. Coleus and Pothos ivy propagate easily from a leaf and stem. Many succulents easily propagate from leaves placed in the soil including the kalanchoe, Christmas cactus, and the hoya.

Students will be asked to make predictions as to whether or not they can root these cuttings to record their predictions in the science *learning log*, and to track the changes in the plant parts over time. Drawings and recording of anecdotal observations are to be made in their science *learning log*. Students should compare the similarities and differences between the new plant and the parent plant. The students will conclude that some plants can be propagated from leaf cuttings.

Students should discuss how this type of propagation is different from the growth of plants using seeds. Can they demonstrate that this is a new plant or really just a new growth of an existing plant? Students may see this as an example of a question that can be proven through further inquiry. Have students compare the ability of a plant to grow from a part to that of animals and to think about whether or not animals can grow another entire animal from an animal part (cutting). Good examples of animals that can regenerate from parts are planaria worms and starfish, although there is a limit to how small a part can be used to regenerate a complete animal.

Revisit the *SQPL* ([view literacy strategy descriptions](#)) question list and answer any questions related to the above activity. Have students record the questions and answers in their science *learning logs*.

Activity 9: Who’s Your Parent, Who’s Your Baby? Animal Life Cycle (GLEs: 7, 10, 47, 49)

Materials List: drawing or photographs of animals at various stages of development, crickets, grasshoppers and/or mealworm larvae, mealworm media, container for mealworms

To investigate animal life cycles, the teacher may use an activity similar to “Are You Me?” found in *Project Wild: Aquatic*. Prepare drawings or collect photographs of animals that represent an early stage and an adult stage of each animal’s life cycle. For example, pictures of puppies, adult dogs, calves, cows, caterpillars (larvae), and butterflies can be used. The students will be broken into two teams. Each student in Team One will receive an illustration of the adult stage that matches the illustration of an early stage held by a student in Team Two. (For example, a drawing of a larva could match with a butterfly.) Instruct students to match the young animal with the adult.

After the activity, introduce the concepts of *complete* and *incomplete metamorphosis*. Grasshoppers and crickets experience incomplete metamorphosis (egg, nymph, reproductive adult) and mealworms undergo complete metamorphosis (egg, larvae, pupa, and reproductive adult.) All three of these organisms can be obtained at local bait shops, pet stores, or through science supply stores. Students could raise mealworms in the classroom and observe them as they go through their metamorphic stages. (Mealworms are the easiest to raise in a classroom setting.) Students should compare the similarities and differences between the offspring and the parent. From their observations, the students could illustrate the life cycle of insects that undergo each kind of metamorphoses. An alternative to raising insects in the classroom would be for the students to use teacher-selected reading materials or the Internet to research and illustrate the life cycles.

Activity 10: Circulatory and Respiratory Systems (GLEs: 42)

Materials List: Circulatory and Respiratory Vocabulary Self-Awareness Chart BLM (1 per student), resource materials on circulatory and respiratory systems, Respiratory System Diagram BLM (1 per student), Circulatory System Diagram BLM (1 per student), colors or colored pencils

To determine students' prior knowledge of the circulatory and respiratory system, use the *vocabulary self-awareness* ([view literacy strategy descriptions](#)) chart. Provide a list of words to the students at the beginning of the activity and have them complete a self-assessment of their knowledge of the words using the Circulatory and Respiratory Vocabulary Self-Awareness Chart BLM. Later, students can use this chart as a study aid to quiz other students.

Part A: Using textbooks and appropriate resource materials, such as health books, Internet sites, or trade books, students will be introduced to the organs and functions of the human circulatory and respiratory systems. Make connections to the needs of the previously studied seeds and animals. Explain that most living things have some type of circulatory system and some means to take in and release gases. Ask students to explain how they think that humans take in gases. (They will probably state that they breathe in air.) Introduce the term *inhale* and *exhale*. Provide each student with the Respiratory System Diagram BLM. To illustrate the path of the inhaled oxygen, the students will be directed to draw tiny red circles above the plant and label them as oxygen. The circles will extend to the nose of the human. The students will label the mouth, nose, epiglottis, trachea, bronchi, lungs, and diaphragm and the function of each. They will be directed to extend the red circles into the trachea and lungs. To model exhalation of carbon dioxide, the students will draw blue circles that will exit the lungs, following the path mentioned above. The students will label the blue circles as "carbon dioxide." Explain to students that plants make oxygen and animals exhale carbon dioxide and that both living things are dependent on the other for these gases.

Introduce the meaning of the term *system* and have the student name the parts of the respiratory system. The students may design skits to demonstrate how the respiratory system works.

Part B: Ask the students to think of a smaller word that comes to mind when they see the word *circulate*. (They may say a circle.) Explain that blood is the substance that is circulated, or makes a circle, in the circulatory system. Explain that just as the respiratory system was made up of a number of parts, so is the circulatory system. The students will be asked if they know what organ helps to pump the blood as it circulates through the body (the heart). They will also be asked if they know what kind of vessel, or container, the blood travels in as it circulates through the body. (Some will say veins or arteries.)

Introduce the major parts of the circulatory system: heart, veins, arteries, capillaries and blood. Provide each student with the Circulatory System Diagram BLM. Explain that the circulatory system and the respiratory system work together to keep humans and other

animals alive. Explain that the heart, which is a muscle, beats to push blood to the lungs to obtain oxygen and to transport it throughout the body and to rid the body of the carbon dioxide waste. Color the pulmonary artery blue as the blood is rich in carbon dioxide, a waste product of the body. Explain that arteries carry blood away from the heart, and the pulmonary artery is the only artery that carries carbon dioxide rich - oxygen poor blood. The students will be instructed to color the pulmonary vein red, as the teacher explains that it is bringing dissolved oxygen from the lungs to the heart. (Note: Veins carry blood to the heart. The pulmonary vein is the only vein in the body that carries blood rich in oxygen. All other veins carry blood that is rich in carbon dioxide back to the heart.) Explain that the heart beats to push this blood back into the heart and then into the aorta artery to the rest of the body. Color the aorta red and trace the artery that leads from it to the body. Explain that as the blood carries oxygen to the muscles, it collects waste products including carbon dioxide from the working muscles. This carbon dioxide is formed as a result of the body breaking down the carbohydrates and fat for energy. Compare this to the exhaust fumes that are created from the burning of gasoline. The blood gradually decreases in the amount of oxygen it contains and increases in the waste materials that act like poisons in the body. The blood then begins a trip back to the heart and lungs to get rid of the carbon dioxide and to gather more oxygen. Trace the path of the blood through the capillaries, into the veins, and to the heart.

Explain to students that although we color most veins blue to indicate that they carry blood that has lost some of its oxygen, the blood is not really blue in the veins. Venous blood is actually a deep maroon to red-violet color. Blood turns red in the presence of oxygen.

The student will explain the process of circulation and respiration to another student, using his/her illustration.

Have students revisit the Vocabulary Self-Awareness Chart BLM and reassess their knowledge of each word. If students still have checks or minuses, be prepared to provide extra instruction for these students.

Sample Assessments

General Guidelines

Assessment techniques should include use of drawings/illustrations/models, laboratory investigations with reports, laboratory practicals (problem-solving and performance-based assessments), group discussion and journaling (reflective assessment), and paper-and-pencil tests (traditional summative assessments).

- Students should be monitored throughout the work on all activities via teacher observation of their work and science learning log entries.
- All student-developed products should be evaluated as the unit continues.

- For some multiple-choice items on written tests, ask students to write a justification for their chosen response.

General Assessments

- Design posters of the labeled parts of a plant for presentation to another class
- Draw and label a diagram of photosynthesis.
- Create a short presentation on a specific type of plant, including where the plant grows and its use or value.
- Choose three seeds; describe and diagram where they formed and how they spread.

Activity-Specific Assessments

- Activity 1: The student will sequence the life cycle of a plant given a series of illustrations.
- Activity 5: The student will label the parts of a flower and explain the function of each part.
- Activities 7 and 8: The student will explain ways that plants can reproduce including planting seeds and propagation from other plant parts. The students will contrast the two as one that produces a new individual plant and one that is a new growth from an established individual plant.

Resources

Teacher Resources:

- *Project Wild: Aquatic*. Western Regional Environmental Education Council. 1987. (Contact State Wildlife and Fisheries or the Forestry Department for information on how to receive training to obtain this book.)
- For information on ordering *Wisconsin Fast Plants*[®] contact Carolina Biological Supply Company 1-800-334-5551
- http://teacher.scholastic.com/grade/grades12/mar_booklist.htm - list of books about plants
- Carle, Eric. *The Tiny Seed*. Natick, MA: Picture Book Studio, 1987.
- DePaola, Tomie. *The Legend of the Bluebonnet*. New York: Putnam, 1983.
- Watt, Claire. "Plants." *Make It Work!* Chicago: World Book, Inc., 2001.

Internet Sites:

- <http://vilenski.org/science/humanbody/index.html> - contains a virtual tour of the human body with online quizzes.
- <http://yucky.discovery.com/noflash/body/pg000131.html> - from discovery kids provides information on the circulatory and respiratory system
- <http://www.ama-assn.org/ama1/pub/upload/images/446/circulationgeneral.gif> - provides a detailed labeled diagram of the circulatory system
- <http://www.innerbody.com/image/cardov.html> - interactive diagram of the circulatory system
- <http://www.medtropolis.com/VBody.asp> - virtual tour of the heart
- http://www.kidshealth.org/kid/stay_healthy/ - information on how the body uses proteins, carbohydrates, and fats
- <http://www.Botany.com> - online encyclopedia of plants
- <http://www.botanical-online.com/lasplantasangles.htm> - main parts of a plant with activities, crosswords, and matching games
- <http://www.fossweb.com/modules3-6/StructuresofLife/index.html> - students can manipulate the stages of the life cycle of brine shrimp, ladybug, butterfly, coconut, fern, mosquito, and snake to place them in the correct order
- <http://www.urbanext.uiuc.edu/gpe/index.html> - The Great Plant Escape - provides investigations and resources for learning about plants and their parts

**Grade 4
Science
Unit 5: Ecosystems**

Time Frame: Approximately five weeks



Unit Description

This unit builds on the previous unit “Living Organisms” by undertaking a deeper study of ecosystems. The unit provides opportunities to construct and care for a model ecosystem as well as to research and report on actual ecosystems in Louisiana and around the world.

Student Understandings

Students will describe and explain the relationship between the components of an ecosystem. Students will diagram the directional flow of energy in a food chain. A model ecosystem will be designed and constructed by students. Students will identify and/or describe man’s impact on ecosystems in Louisiana. Students will research how adaptations allow organisms to survive in and modify their habitats to meet their needs.

Guiding Questions

1. Can students describe the components of an ecosystem?
2. Can students describe how plants and animals depend on each other in an ecosystem?
3. Can students describe how habitats are different from each other?
4. Can students explain how endangered animals can make a comeback?
5. Can students explain how an animal’s adaptations enable it to survive in a specific habitat?

Unit 5 Grade-Level Expectations (GLEs)

GLE #	GLE Text and Benchmarks
Science as Inquiry	
1.	Ask questions about objects and events in the environment (e.g., plants, rocks, storms) (SI-E-A1)
2.	Pose questions that can be answered by using students’ own observations, scientific knowledge, and testable scientific investigations (SI-E-A1)
3.	Use observations to design and conduct simple investigations or experiments to answer testable questions (SI-E-A2)

GLE #	GLE Text and Benchmarks
4.	Predict and anticipate possible outcomes (SI-E-A2)
10.	Express data in a variety of ways by constructing illustrations, graphs, charts, tables, concept maps, and oral and written explanations as appropriate (SI-E-A5) (SI-E-B4)
11.	Combine information, data, and knowledge from one or more of the science content areas to reach a conclusion or make a prediction (SI-E-A5)
12.	Use a variety of appropriate formats to describe procedures and to express ideas about demonstrations or experiments (e.g., drawings, journals, reports, presentations, exhibitions, portfolios) (SI-E-A6)
14.	Identify questions that need to be explained through further inquiry (SI-E-B1)
15.	Distinguish between what is known and what is unknown in scientific investigations (SI-E-B1)
18.	Base explanations and logical inferences on scientific knowledge, observations, and scientific evidence (SI-E-B4)
21.	Use evidence from previous investigations to ask additional questions and to initiate further explorations (SI-E-B6)
22.	Explain and give examples of how scientific discoveries have affected society (SI-E-B6)
Life Science	
41.	Describe how parts of animals' bodies are related to their functions and survival (e.g., wings/flying, webbed feet/swimming)) (LS-E-A3)
47.	Sequence stages in the life cycles of various organisms, including seed plants (LS-E-B1)
50.	Explain how some organisms in a given habitat compete for the same resources (LS-E-C1)
51.	Describe how organisms can modify their environment to meet their needs (e.g., beavers making dams) (LS-E-C1)
52.	Describe how some plants and animals have adapted to their habitats (LS-E-C2)
53.	Identify the habitat in which selected organisms would most likely live and explain how specific structures help organisms to survive (LS-E-C2)
54.	Describe the effect of sudden increases or decreases of one group of organisms upon other organisms in the environment (LS-E-C3)
Science and the Environment	
70.	Design an ecosystem that includes <i>living (biotic)</i> and <i>nonliving (abiotic)</i> components and illustrates interdependence (SE-E-A1)
71.	Describe and explain food chains/webs and the directional flow of energy in various ecosystems (e.g., construct a model, drawing, diagram, graphic organizer) (SE-E-A2)
72.	Predict and describe consequences of the removal of one component in a balanced ecosystem (e.g., consumer, herbivores, nonliving component) (SE-E-A2)

Sample Activities

Activity 1: Ecocompetition (GLEs: 1, 2, 4, 14, 18, 50)

Materials List: Ecosystem Vocabulary Self-Awareness Chart BLM (1 per student), fast germinating seeds or bird mix, soil, paper cups, water, science learning logs

Ask students if they can remember a time when they played in a park or in their backyards and to describe any animals or insects they encountered at that time. Ask students where they think the animals or insects may have come from and where do they live. The teacher will introduce the concept of an *ecosystem*. Remind students that any system is made of parts that work together. (example: organ systems, digestive system, etc.) In an ecosystem, non-living (abiotic) and living things (biotic) interact with each other and often depend on each other for renewal (as in non-living things) or for survival (as in living things.)

In their science *learning logs* ([view literacy strategy descriptions](#)), instruct students to create a KWL chart, a *graphic organizer* ([view literacy strategy descriptions](#)), by drawing three vertical lines down their paper to divide their page into three columns. Have students label their columns “K,” “W,” and “L.” This strategy will help to access prior knowledge of organisms, habitats, and ecosystems and help students to identify questions that will require investigation. Under the “K,” have the students list any information that they know about organisms, habitats, and ecosystems. Under the “W,” have students list any questions they may have about organisms, habitats, and ecosystems. Hold a class discussion where students share their responses and construct a class KWL chart, identifying any questions that can be answered through investigation.

Direct students to complete a *vocabulary self-awareness chart* ([view literacy strategy descriptions](#)) to assess their knowledge of vocabulary related to the unit. Distribute one copy of the Ecosystem Vocabulary Self-Awareness Chart BLM to each student. Have them place a “+”, “√”, or “-” depending on their level of understanding. For example,

Word	+ (under-stand well)	√ (limited under-standing or unsure)	-- (don't know)	Example	Definition
ecosystem					
habitat					

Continue to develop vocabulary as needed for this unit.

Describe an example of an ocean ecosystem with the aid of student input. Ask students to suggest examples of things (both living and nonliving) that can be found in the ocean and list them on the board. Through discussion, have students classify examples as *biotic*

and *abiotic*. Next have students describe the size of the oceans. (large and vast) Ask the students why they think the oceans are so large. This should lead into a discussion of the concepts of carrying capacity and space.

Instruct the students to sit close together in a group on the floor. Introduce the ideas of *carrying capacity* and *space*. To help students better understand the concept of *carrying capacity*, ask them if they have ever noticed the sign in all elevators that specifies the number of people who can safely ride in the elevator. This is the carrying capacity of that elevator. Likewise, there will be a maximum number of individuals of a particular species that an ecosystem can successfully carry (support) over a period of time because of limiting factors such as resources, temperature, space, etc.

During the lesson, connect the physical proximity of the students to the idea of *space*. Discussion: How do you react if someone sits too close to you? What happens if too many things (e.g., people, animals, other organisms) occupy a particular space? The teacher will record students' comments/predictions on chart paper. The concept of *crowding* can be illustrated either by a teacher demonstration or student-led activity as follows: Plant equal amounts of a fast germinating seed (cheap, mixed bird seed is an excellent choice) in two containers; one where the seeds are at least 2.5 cm. apart and the other where the seeds are planted extremely close together. In their science *learning logs*, students can create a table and record the number of seeds that germinate in each container. Students will continue to observe and record the data over several weeks, noting the size, color, height, etc. of each plant. (After a period of time, the crowding effect will be noted in a variety of ways, including dying, becoming thinner, making smaller plants, etc.) Students should record observations, make inferences, and relate this to both carrying capacity and space. Ask students why the seeds that were planted further apart had better germination and growth than the seeds that were planted close together? (The seeds are competing for the same space.) Guide students to conclude that the plants in that space compete for the same resources. Therefore, when the plants are crowded their growth is affected because there are not enough resources to sustain all the plants. An alternate to this activity, if space is available on the schoolyard, would be to plant plots of birdseed mixture and observe over time.

Ask students if they can think of other examples of plants and/or animals competing for the same resource.

Activity 2: Adaptations (GLEs: 10, 11, 18, 41, 50, 51, 52)

Materials List: tan toothpicks or green yarn, maroon yarn, yard stick, stopwatch, teacher-selected resources on beavers, nutria, and fire ants, science learning logs

In their science *learning logs* ([view literacy strategy descriptions](#)), have students write the name of an animal and describe how various parts of that animal's body are related to their functions and survival (needle-like beaks for obtaining nectar, webbed feet for swimming, etc.) Students should share their answers during a class discussion. After

listening to the class discussion, ask students if they can name two different types of organisms that live in the same habitat and compete for the same resources. Explain to students that because of this competition sometimes animals must adapt to ensure their survival in a habitat. Discuss the concept of *adaptations*.

To introduce the students to the concept of *camouflage* as an adaptation, the teacher will divide the class into two groups. Each group will represent a different species of bird, each of which has a different diet. Prior to completing the activity, the teacher will prepare quantities of the bird food (tan toothpicks if the schoolyard grass outside is yellow; green yarn segments if the grass is green, in addition to maroon yarn segments cut the same length as the toothpicks.) Spread the toothpicks/yarn on a 20 square foot demarcated plot of grass prior to the activity. Before going outside, introduce the terms *predator* and *prey*. Assign each team a color of toothpick/yarn (prey) to find. The student bird teams (predators) will take turns trying to locate their specific type (prey) within a one-minute interval. Each team will count the total number of items found, record the data in their science *learning logs*, and compare the totals with that of the other teams. In their science *learning logs*, have students address the following questions. Which team collected the most items? Why do you think this team was able to collect more items? Have students discuss their answers in small groups. Conduct a whole class discussion about the concept of *camouflage*. Through questioning and discussion, guide students to conclude that the adaptation of protective coloring and camouflage helps prey to hide from their predators.

Sometimes plants and animals modify the space that they live in for their benefit. This also often produces competition for resources. Instruct students to research the beaver and the adaptation that it has for modifying a stream to create its den, how these changes are beneficial to the beaver and other animals but are harmful to others, including man. (A good resource is found in the Louisiana animals section at <http://www.alligatorfur.com> and then click on Educational Materials found in the green banner at the top of the homepage.) Other animals that may be of interest are the nutria and fire ant. Students can present their findings in small discussion groups and draw conclusions.

Ask students if they can think of other ways that plants have adapted to their habitat. (mosses that grow on trees, plants that can tolerate salt water, trees drop leaves in winter to minimize water loss, etc.) Students should conclude that plants and animals are capable of modifying their environment to meet their needs and that a plant or an animal's presence in an ecosystem may have positive and/or negative effects on the other members of the ecosystem.

Activity 3: Classroom Ecosystem (GLEs: 1, 2, 3, 10, 11, 12, 14, 15, 18, 21, 50, 54, 70)

Materials List: 2 aquariums, aquarium gravel, fish, small aquatic plants, soil, cleaned 2-liter bottles (1 per terrarium), wicking material (fabric interfacing or cotton string), seeds

of small plants (alfalfa, rye grass, or wheat), pin, utility knife (teacher only), scissors, paper punch, drill and drill bit, waterproof tape, small animals (toads, , crickets, etc), water, mealworms, thermometer, pH paper, salt, Classroom Terrarium Observation Sheet BLM, Classroom Aquarium Observation Sheet BLM, safety goggles, science learning logs

Teacher Note: Carefully consider the supplies that will be needed to complete the different parts of this activity.

Safety Note: Have students identify the safety precautions necessary for handling sharp objects (the utility knife used to cut the two-liter bottles should only be handled by the teacher), insects or other animals (use caution when handling insects and animals), and soil (wash hands after handling soil).

Students will set up a classroom terrarium and aquarium—each will constitute a separate ecosystem. Students will also establish smaller terrariums in plastic bottles that will be used in their investigations. Resources, ideas, and directions for these can be found in textbooks, trade books, science kits, and *Bottle Biology* available online at <http://www.bottlebiology.org>. Tips for setting up a classroom aquarium can be found at <http://www.tetra-fish.com/>. A classroom aquarium and terrarium allow the students the opportunity to observe larger animals, such as toads and frogs, which cannot be used in the smaller plastic bottle setup.

Part A: Classroom Terrarium and Aquarium

Ask students to make suggestions for the animal life to put in each classroom ecosystem. In both of the classroom systems, the students will establish plant life prior to admitting animal life. Instruct students to research the diets of the animals that they chose to place in the systems. Ask the students which type of animal should be introduced first (the plant eaters or the meat eaters) and have them to defend their reasoning. The students should also begin to think about how the prey is adapted to hiding or escaping its predator. Using the Classroom Terrarium Observation Sheet BLM and the Classroom Aquarium Observation Sheet BLM, the student pairs will keep daily records on the appearance of the plants and animals in the classroom ecosystem models. They will record the temperature and the number of animals seen, describe the amount of condensation in the terrariums and the appearance of the plants and animals, and record their findings on a class chart. Sketches may be included along with written descriptions. Students will make decisions as they learn to maintain terrariums and aquariums. For example, they will monitor the growth of decomposers that may threaten the health of the plant life and decide to remove decaying plants and reduce the amount of water that they are adding to the system. They should also monitor the amount of light (artificial or sunlight), temperature, and growth of algae in the aquarium to make decisions regarding the placement of the aquarium and when it should be cleaned.

Ask students to identify the living (biotic) and nonliving (abiotic) elements in each ecosystem and identify the importance of each to the system. Students will develop a *graphic organizer* ([view literacy strategy descriptions](#)), such as a web or chart, for the

aquarium with the two beginning branches being living and nonliving. Use this same activity with the terrarium. The teacher will facilitate a discussion that enables students to make the connections among the biotic and abiotic elements and emphasize the dependence of living things on non-living matter. A brief discussion of the role of decomposers will lead the students to become aware of the function of these organisms in renewing the abiotic components of the ecosystem. The students will write entries in their science *learning log* ([view literacy strategy descriptions](#)) reflecting on the interdependence found in ecosystems.

Instruct students to generate a list of questions related to the ecosystems and to share their questions and record them on a chart. Students should identify which questions could be answered through investigations.

Part B: Small Group Ecosystems

Using a modified version of the Ecocolumn design (similar to the Kimchee model described on the Bottle Biology website), each student group will need one empty plastic soda bottle which has had its top third removed and punctured with a pin to create air holes. (For safety purposes the teacher should prepare the bottles by cutting them and punching the holes). Add soil and plant seeds such as alfalfa, rye grass, and wheat. Water the soil thoroughly and replace and tape the capped top back on to the area where it was cut. The caps can be unscrewed to add more water. Allow plant life to be established in the individual terrarium before adding small animals or starting the investigations in part C.

Part C: Students will design investigations using their plastic bottle ecosystem models in which they test one of the following topics: 1) introduction of competing insects, 2) the effect of removing herbivores or carnivores from a system, 3) the addition of pollutants or the intrusion of saltwater into a freshwater system, 4) the effects of too much water in the system, and 5) the effects of excessive decomposer growth on the system. The student groups will determine which internal or external factors they will investigate. The students will write a hypothesis and test the hypothesis, establishing controls and variables. The students will keep careful records of temperature, added water, added salt, the number of added species and other variables that are applicable to their investigations. They will analyze data, graph results, and make appropriate conclusions. Students from each group will periodically report to another group to make observations and be updated with the accumulating data. The results of each investigation will be shared in presentations with the entire group. All students will be responsible for learning the unit concepts from the presenting groups and will discuss the results, evaluate the lab design, evaluate the presented data, and draw conclusions about each lab. The students will record the conclusions to each investigation in their science *learning logs* and should identify and submit a list of questions that need to be explained through further testing and investigation.

Part D: If possible, secure small animals such as frogs, crickets, and mealworms (found at bait shops and pet stores) and observe their life cycles in a setting other than in the two systems described above. In their science *learning logs*, the students will illustrate and

compare their life cycles and observe the effects of the addition of these to the classroom terrariums, when applicable.

Activity 4: Food Chain (GLEs: 1, 2, 10, 12, 71, 72)

Materials List: pictures of plants, animals, and mushrooms, large index cards, permanent marker, yarn, hole punch, brown paper bags, popped corn, timer, whistle, construction paper cut into 2 inch wide strips, tape, science learning logs

Part A: Define and discuss the terms *producers*, *consumers*, and consumer types such as *herbivores*, *carnivores*, *omnivores*, and *decomposers* and provide common examples of each. Using posters, pictures from magazines, and/or calendars, prepare cards of animals, mushrooms, and plants for students to classify as producers, consumers, and consumer types such as herbivores, carnivores, omnivores, and decomposers. Divide students into groups and have each group classify the pictures into the above listed categories. Pair up student groups and have each group explain and defend their classification of each picture.

Students should begin wondering how the animals in their ecosystem models fit into the consumer classifications. Using the animals and plants in the aquarium and terrarium, the students will design food chains beginning with the producers. To emphasize the idea that the energy source that ultimately powers the food chain is the Sun, have students draw a small Sun icon prior to the name of the producer in the chain. Instruct students to use the standard notation of producer → (representing the flow of energy and stated as “eaten by”) herbivore → carnivore. (Marsh grasses → insects → hatchling alligators → raccoons → adult alligators → people) Ask them what the arrow represents (The flow of energy from one organism to another). If there is a visible decomposer or fungi in the class ecosystem, add it to the chain or have students suggest the decomposers that may be present such as bacteria which they can’t see.

Part B: The students will take part in an activity that focuses on food chains and balance within a community. Ask students to name weather related events that could cause plants and animals to die or have to flee from an area (floods, storms, fire from lightning). Encourage a discussion about the results that the elimination of a producer or consumer could have on the rest of the members of a community and to the ecosystem.

To help students understand the concept that populations undergo constant change and are limited by other members in a food chain, the students will take part in a physical activity that involves competition within an ocean food chain. Prepare large index cards to be used as hanging name tags that are labeled anchovies, sardines, and sea gulls. Randomly assign the roles of these consumers to students and have them wear the appropriate index card around their necks. Give each student a bag in which to collect their food. Popped corn will represent algae, the producer in an ocean food chain. Have students identify the necessary safety precaution when handling food items in the lab and when moving around during a lab. (The popped corn is not to be consumed and they will

need to take precautions as to not hurt each other when their turn comes to gather their food.) Separate the class into three unequal groups. The members of the anchovy group will be the largest group, with the sardines and seagull groups each diminishing in size respectively. (For a class of 20 students, anchovies would be represented by 10 students, sardines by 7, and seagulls by 3.) Pour the popped corn onto the ground in a large circular area. The anchovies will sit on the ground in a circle around the algae. The sardines will stand in a circle around the anchovies, and the seagulls will stand in a circle behind the anchovies. When the activity begins, the anchovies will be allowed 30 seconds to gather as much popped corn as they can in their bags. Remind students not to run or bump into each other. They may walk fast. The teacher will blow a whistle to signal the arrival of the next consumer. Then, the sardines will be allowed to go hunting for 30 seconds, chasing the anchovies and gathering the food energy from the anchovies that they must pour into the sardine's bag. The captured or eaten anchovies must sit in a retired zone. The seagulls will be allowed 30 seconds to chase and collect food from the sardine students who will sit out once they are eaten. Any student who fails to eat will also be removed from the game. Students will observe and discuss how energy is being passed from producers to consumers. They will also observe how the number of producers and lower consumers is diminishing. All students will return the popped corn to the teacher before the next round is played. The teacher will return some of the "eaten" students to their respective circles as well as some of the popped corn to represent increases in each population made by those who survived. The number of producers and lower consumers should remain less than there was in the previous round. Continue the activity, until the number of consumers outweighs the food available. Ask students what must happen to each consumer group as the food diminishes. (Students will infer that the consumers would have to leave the area and that some would die.) Ask the students what would happen to the algae, if there are fewer anchovies to eat it. (Students will conclude if there are enough producers left to reproduce, their population will increase which will jumpstart the food chain again.)

Part C: Introduce students to the members of a Louisiana forest community. Have students design food chains found in that ecosystem by writing the name of organisms found in the forest community on separate strips of construction paper and then link the strips together to create a food chain. The next step is for students to link the food chains into food webs. Students should discuss the interdependence of the members of the community. In their science *learning logs* ([view literacy strategy descriptions](#)), students will write a paragraph in which they describe the possible effects of removing various members of a given food chain or web. They will predict what the results would be on the other members of the chain or web. Have students share their entries.

Activity 5: Researching Ecosystems (GLEs: 10, 11, 12, 18, 41, 47, 50, 51, 52, 53)

Materials List: multimedia resources and books on Louisiana ecosystems and Louisiana plants and animals, encyclopedias, construction paper, scissors, glue, colors, copy paper, markers, pictures of Louisiana plants and animals, shoe boxes, loose-leaf paper,

Louisiana Ecosystem Research Sheet BLM (1 per student), Louisiana Animal Research Sheet BLM (1 per student), science learning logs

Part A: Using multimedia or other resources have students work in cooperative groups to research a specific ecosystem, being sure that several Louisiana examples are included (coastal marsh, freshwater marsh, prairie, freshwater lakes/bayous, bottomland hardwood forest, piney wood forest, etc.) Their research should include the plant life, soil types, water availability and salinity, and major animal types that live in their chosen ecosystem. Direct students to record their information on the Louisiana Ecosystem Research Sheet BLM. If possible, have students locate a picture representing the ecosystem. As a finished product, have student complete a *RAFT* Writing ([view literacy strategy descriptions](#)). Students will take on the role of an advertising agent for a Louisiana ecosystem tour group and will design an advertisement in the form of a brochure to distribute to perspective tourist to Louisiana. In their brochures, students will highlight important features of their ecosystem. Student groups will make oral presentations of their brochures to the class.

Part B: Next, instruct student pairs to research an animal that resides in Louisiana, using multimedia resources, books, or encyclopedias. Provide a list of animals that should include mammals, fish, crustaceans, amphibians and reptiles. Lists of suitable animals can be found at various web sites such as the Fur and Alligator Advisory Council, www.alligatorfur.com, and the Louisiana Wildlife & Fisheries, <http://www.wlf.state.la.us/experience>. Information gathered can be recorded on the Louisiana Animal Research Sheet BLM. Instruct student pairs to write a script for an interview with the animal that will include information about its behavior, life cycle, adaptations that help it to survive in its habitat, how it modifies its habitat, its main prey and predators and other animals it competes with for resources. Students should also include how their animal's various body parts are related to their function and survival. Have students role play the interview with the animal. After each presentation, the class will discuss with the presenters the following topics: What effect does the animal have on its habitat? What effect would a sudden decline in the numbers of the given animal have on the other organisms in the ecosystem?

Part C: As a culminating activity, the students, working in interest groups of 2-3, will create a diorama of a particular Louisiana habitat and place drawings of the animals that they have researched into the diorama. Have students go on a gallery walk to observe the ecosystem dioramas. This would be a good time to invite parents to school for an ecosystem extravaganza where the students present their dioramas and brochures. If possible, take students on a field trip to one or more of Louisiana's ecosystems.

Activity 6: In Balance (GLEs: 1, 12, 22, 71, 72)

Materials List: photos of pest damage, multimedia resources and books on threatened and endangered Louisiana plants and animals, encyclopedias, blank postcards, addresses of Louisiana legislators, stamps, science learning logs.

The teacher will introduce the activity by asking students to define a *pest* (a plant or animal that causes harm) and to discuss why *pesticides* (chemicals that control pests) are used to control insects, rodents, weeds and disease organisms. Ask students if they know of any examples of pesticides that their family might use (mosquito spray, head lice medication, flea powder for dogs and cats, roach spray, weed killers, fire ant granules, vegetable garden sprays, etc.). Point out that in order to grow crops (corn, rice, cotton, wheat, etc.) to feed millions of people and animals, it is necessary to use some type of pest control. Photos of locust damage or other examples of pest damage could be shown to students, if available.

Ask students to think about where the pesticides go after they are applied to a home lawns or gardens or even to a farmer's crop. (Students should recall the water cycle model studied in Unit I). Through questioning guide the students to infer that many of the pesticides end up in the waterways of our state and eventually in the ocean.

Share with students that many years ago, the number of birds, such as the Louisiana state bird, the Brown Pelican and our National bird symbol, the Bald Eagle, began to decrease in numbers. Point out that scientists were initially puzzled as they discovered that the egg shells of many of these birds was so thin that they broke in the nest before they were able to hatch, resulting in the death of the bird long before it was able to develop successfully.

Ask students to pretend that they were biologists assigned to determine what was causing this problem. What would they look for that was common to both birds, even though they may have lived thousands of miles apart? Assist students in drawing a food chain that includes the pelican, showing the plankton → small fish → larger fish → pelican diagram. Repeat a food chain diagram for the eagle. Have students compare the two food chains and indicate which factors are the same that may be causing the problem (diet of fish). Tell students that scientists discovered that the dead birds also had high levels of a pesticide, DDT, in their bodies. How could it have gotten there? (From the fish) Point out that DDT was being used all over the country to control insect pests on crops as well as in home gardens, etc. Guide students to draw the conclusion that DDT found in the bodies of the birds came from the fish eaten by the birds and that is what could have weakened the eggshells. Ask students what they think that the government and our society's reactions were to this loss of bird population. (Laws banning the use of DDT and protecting endangered species and habitat were passed.) Guide students to conclude that advances in Science can lead to societal changes.

Point out to students that the use of DDT has saved literally millions of lives in underdeveloped countries by controlling insects that transmit malaria, yellow fever, and other life-threatening diseases.

Instruct students to choose a plant or animal, native to Louisiana that is considered threatened or endangered. A list of these plants and animals can be obtained from the LA Dept of Wildlife & Fisheries (LWLF) website, available at <http://www.wlf.louisiana.gov/experience/threatened/>. Using multimedia resources, books,

and encyclopedias, have students research the habitats and any adaptations that caused or might cause the organism to become endangered and also which might help it to recover. Based on available information and resources, have students predict what human activities or actions have impacted the population of the animal in question and to draw conclusions about the consequences of these actions and conditions for the organism. Have students explain what effect the removal of their plant or animal will have on the balance of the ecosystem. All findings should be recorded in their science *learning logs* ([view literacy strategy descriptions](#)).

Contact LWLF and have a spokesperson speak to the class on efforts to protect some of these animals (and plants). Representatives from the Cooperative Extension Service and universities may also be called upon to be a guest speaker. Students will prepare a list of questions to ask the spokesman about their chosen plant or animal in advance of the presentation. After the presentation, have students prepare postcards summarizing what they have learned and mail the postcards to government officials, such as their legislator, and encourage them to continue protecting wildlife.

Sample Assessments

General Guidelines

Assessment techniques should include use of drawings/illustrations/models, laboratory investigations with reports, laboratory practicals (problem-solving and performance-based assessments), group discussion and journaling (reflective assessment), and paper-and-pencil tests (traditional summative assessments).

- Students should be monitored throughout the work on all activities via teacher observation of their work and lab notebook entries.
- All student-developed products should be evaluated as the unit continues.
- For some multiple-choice items on written tests, ask students to write a justification for their chosen response.

General Assessments

- Students will make daily observations of the conditions in the aquarium and terrarium.
- Students will construct simple food chains.
- Students will use the scientific process to design investigations.
- Students will classify animals according to their consumption.
- Students will report their findings to the class in a variety of formats.
- Students will discuss conservation efforts.

Activity-Specific Assessments

- Activity 2: Students will explain how some animals have behavioral adaptations that allow them to alter the environment for their own benefit. They will discuss how the behavior benefits some, but is harmful to others.
- Activity 4: Students will identify the producers and consumers given a series of illustrations. Students will classify consumers as herbivores, carnivores, omnivores, and decomposers and explain the role of each in a food web. The students will also illustrate a food web.
- Activity 6: The students will identify the main reasons that selected Louisiana animals and plants are endangered or have become extinct. They will describe methods that citizens have taken to protect wildlife within the state.

Resources

- *Ecosystem, Nature in Balance*. CD-ROM, AIMS software
- *The Living Planet*. Video set. 1984.
- Parker, Steve. *The Random House Book of How Nature Works*. New York: Random House, Inc., 1993.
- Ryder, Joanne. *Chipmunk Song*. New York: E. P. Dutton, 1987.
- *Project WILD*. Contact for workshop and materials at <http://www.projectwild.org/>
- Tips for setting up a classroom aquarium can be found at <http://www.tetra-fish.com/>
- Ingram, Mrill. *Bottle Biology*. Iowa: Kendall/Hunt Publishing Company, 1933. or <http://www.bottlebiology.org>
- <http://www.wlf.louisiana.gov/experience/threatened/> - Louisiana Department of Wildlife and Fisheries list of threatened or endangered species in Louisiana
- www.alligatorfur.com - provides a list of Louisiana animals; click on Educational Materials
- http://www.marshmission.com/coastal_correspondent/ccindex.htm - online articles related to wetlands written for student audiences

Grade 4
Science
Unit 6: Planet Earth and Its Moon

Time Frame: Approximately ten weeks



Unit Description

During this unit, activities explore some of the processes and cycles experienced at Earth's surface. Investigations involve the slow weathering processes and the effects of erosion, violent geological events, the water cycle, the study of weather, and the effects of human efforts to manage and use natural resources. Additional activities provide an opportunity to study the Earth, Moon, and Sun patterns.

Student Understandings

Students will model various processes that weather and erode the Earth. After making observations, students will classify rock samples as igneous, metamorphic, or sedimentary rocks and produce a life cycle story chain. Students will model the formation of sedimentary rocks and explain the relative ages of the sedimentary rock layers. Students will diagram the water cycle, research weather events, and make posters explaining weather safety measures. Using student-created weather instruments, daily weather data will be collected and used to make weather predictions. Students will explain what causes the seasons. Diagrams of the lunar cycle will be created and explanations will be written explaining the causes of eclipses. Students will research space missions and write a report explaining how the missions have advanced our knowledge of the universe.

Guiding Questions

1. Can students identify some processes and cycles that change Earth's surface?
2. Can students define the term *soil*?
3. Can students explain how to determine different properties of minerals and rocks?
4. Can students describe how weathering and erosion affect the location of human communities?
5. Can students explain the water cycle?
6. Can students use simple weather gathering tools to predict the weather?
7. Can students discern a pattern in observing the Moon?

Unit 6 Grade-Level Expectations (GLEs)

GLE #	GLE Text and Benchmarks
Science as Inquiry	
1.	Ask questions about objects and events in the environment (e.g., plants, rocks, storms) (SI-E-A1)
2.	Pose questions that can be answered by using students' own observations, scientific knowledge, and testable scientific investigations (SI-E-A1)
3.	Use observations to design and conduct simple investigations or experiments to answer testable questions (SI-E-A2)
4.	Predict and anticipate possible outcomes (SI-E-A2)
6.	Use a variety of methods and materials and multiple trials to investigate ideas (observe, measure, accurately record data) (SI-E-A2)
7.	Use the five senses to describe observations (SI-E-A3)
8.	Measure and record length, temperature, mass, volume, and area in both metric system and U.S. system units (SI-E-A4)
9.	Select and use developmentally appropriate equipment and tools (e.g., hand lenses, microscopes, graduated cylinders) and units of measurement to observe and collect data (SI-E-A4)
10.	Express data in a variety of ways by constructing illustrations, graphs, charts, tables, concept maps, and oral and written explanations as appropriate (SI-E-A5) (SI-E-B4)
11.	Combine information, data, and knowledge from one or more of the science content areas to reach a conclusion or make a prediction (SI-E-A5)
12.	Use a variety of appropriate formats to describe procedures and to express ideas about demonstrations or experiments (e.g., drawings, journals, reports, presentations, exhibitions, portfolios) (SI-E-A6)
13.	Identify and use appropriate safety procedures and equipment when conducting investigations (e.g., gloves, goggles, hair ties) (SI-E-A7)
17.	Recognize that a variety of tools can be used to examine objects at different degrees of magnification (e.g., hand lens, microscope) (SI-E-B3)
18.	Base explanations and logical inferences on scientific knowledge, observations, and scientific evidence (SI-E-B4)
19.	Describe procedures and communicate data in a manner that allows others to understand and repeat an investigation or experiment (SI-E-B5)
20.	Determine whether further investigations are needed to draw valid conclusions (SI-E-B6)
Physical Science	
38.	Explain the effects of Earth's gravity on all objects at or near the surface of Earth (PS-E-C5)
Earth and Space Science	
55.	Recognize that sedimentary rocks are composed of particles that result from weathering and erosion (e.g., sandstones, conglomerates) (ESS-E-A1)
56.	Investigate the properties of soil (e.g., color, texture, capacity to retain water, ability to support plant growth) (ESS-E-A1)

GLE #	GLE Text and Benchmarks
57.	Explain how unequal heating of Earth's land and water affects climate and weather by using a model (ESS-E-A2)
58.	Draw, label, and explain the components of a water cycle (ESS-E-A3)
59.	Measure, chart, and predict the weather using various instruments (e.g., thermometer, barometer, anemometer) (ESS-E-A4)
60.	Identify various types of weather-related natural hazards and effects (e.g., lightning, storms) (ESS-E-A4)
61.	Identify safety measures applicable to natural hazards (ESS-E-A4)
62.	Classify rocks and minerals according to texture, color, luster, hardness, and effervescence (ESS-E-A5)
63.	Demonstrate and explain how Earth's surface is changed as a result of slow and rapid processes (e.g., sand dunes, canyons, volcanoes, Earthquakes) (ESS-E-A5) (ESS-E-A1)
64.	Describe and sequence the phases of the Moon and eclipses (ESS-E-B2)
65.	Compare a solar and a lunar eclipse (ESS-E-B2)
66.	Diagram the movement of the Moon around Earth and the movement of Earth around the Sun (ESS-E-B2)
67.	Explain the changing appearance of the Moon and its location in the sky over the course of a month (ESS-E-B3)
68.	Identify the relationship between Earth's tilt and revolution and the seasons (ESS-E-B4)
69.	Explain how technology has improved our knowledge of the universe (e.g., Hubble telescope, space stations, lunar exploration) (ESS-E-B6)

Sample Activities

Activity 1: The Ever Changing Crust (GLEs: 4, 6, 7, 10, 11, 12, 63)

Materials List: a piece of toast, chart paper, photographs (floods, earthquakes, hurricanes, coastal land loss, erosion, mudslides, volcano eruptions, Grand Canyon), aerial photographs of Louisiana coastline (before and after Hurricane Katrina), empty aluminum soda can, water, access to a freezer, safety goggles, disposable gloves, map of Louisiana, 1 set of each per group (plastic container, limestone, diluted vinegar, painter's pan, soil, spray bottle), 1 set per student (sand, sealable plastic bags, jumbo chalk sticks, toothpicks), science learning logs

Safety Note: Students should identify the safety precautions necessary when handling acids (wear safety goggles, wear disposable gloves, wash hands after lab) and when handling sand (wear safety goggles).

Introduce the four layers of Earth (crust, mantle, outer core, and inner core) and explain how the crust, which is the layer we live on, is the one that we know the most about. The crust, or Earth's surface, is constantly changing. Using a piece of toast, demonstrate how

rubbing your hand over it causes crumbs to form that can fall when shaken or can easily be blown off. Ask students to *brainstorm* ([view literacy strategy descriptions](#)) a list of the changes in the Earth’s crust that they have seen or heard of, including the damage after a local flood, Louisiana’s coastal land loss, the 2004 Asian tsunami, California mudslides, and the eruption of volcanoes or recent earthquakes. Make a list on chart paper of the student responses. If available, show students’ photographs that illustrate the events above. All of these show the constant processes that are at work changing Earth’s crust. Explore several of these processes with students and have students determine if the event represents a sudden change in the Earth’s crust (within a short span of time—minutes, hours, days) or a gradual change (those taking long periods of time—sometimes many millions of years).

Instruct students to create *vocabulary cards* ([view literacy strategy descriptions](#)) using the following vocabulary terms: *weathering, erosion, sediment, sedimentary rocks, metamorphic rocks, igneous rocks, deposit, geology, organic, permeability, evaporation, condensation, precipitation, revolution, rotation, and eclipse.*

Example Vocabulary Card

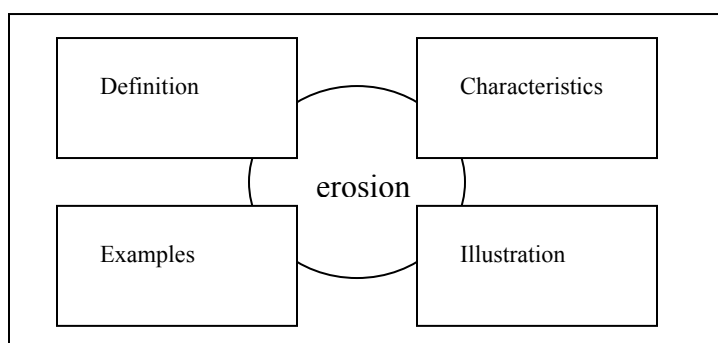

In pairs, have students share their *vocabulary cards*. Hold a class discussion of the words. The *vocabulary cards* can be used later as a study aid for quizzes and tests.

Part A: Weathering

Introduce the term *weathering*. Ask the students if they have ever seen pavement that has buckled. Students will consider what caused this change (tree roots). Relate the buckling to the pressure applied to the rock as the roots grow larger. Encourage students to name other natural agents that could cause rocks to split.

1.) Ask students how they think water could weather a hard rock. The students will model weathering by completely filling an empty aluminum can with water. The students will predict what will happen to the water level and to the can when it is placed in the freezer overnight. The next day the students will observe the level of the ice in comparison to that of the water on the previous day and the condition of the can which may have broken (as the water freezes it may push up and out of the open drink spout). Students will infer how this expansion relates to the weathering of rock. Ask students if the weathering by

ice would take a long or short time to breakup a mountain (slow). Ask the students what is created when a large rock is cracked and broken apart (smaller pieces of rock). Explain that the result of weathering is the creation of smaller materials. A video clip from the site below illustrates water freezing in the joints of the rocks at Niagara Falls (go to site and “click on box for streaming video.”):

<http://www.lpb.org/education/classroom/itv/envirotacklebox/modules/m4erosion.htm>

2.) Have students identify the safety precautions necessary when handling acids. (Wear safety goggles, wear disposable gloves, and wash hands after lab.) To observe how water mixed with acid from decaying plants can breakdown rocks, place several pieces of limestone in a container of diluted vinegar (acetic acid). Direct students to observe the rocks at different intervals and record their observations in their science *learning logs* ([view literacy strategy descriptions](#)). Allow the rocks to sit overnight and then observe the next day. Carefully remove the rocks from the vinegar and observe the vinegar. What is at the bottom of the cup? (Students will observe and conclude that acids help to dissolve away the minerals that make up the rock, creating smaller pieces.)

3.) Have students identify the safety precautions needed when handling sand. (Wear safety goggles) Ask students to design a model of wind weathering using sand, two sealable plastic bags, and chalk. Students should use toothpicks to carve designs in jumbo sticks of outdoor chalk. Place the jumbo stick of outdoor chalk and about a cup of sand in doubled sealable bags and shake the bags vigorously to observe wind weathering. The students should remove the chalk from the bag and observe the chalk sticks after the shaking. Discuss how sand carried by the wind abrades rocks.

Ask students to think of an organism that can further weather a rock once the natural weathering agents have cracked it. Ask them to visualize cracks in the sidewalk. What living thing might they see growing there? (Plants) Students will explain how the roots of plants can crack rocks. In their science *learning logs*, students should summarize the elements of weathering that have been discussed and demonstrated. Instruct students to describe the ways that rocks or mountains can be weathered. The student should also conclude that the process of weathering is a slow process.

Part B: Erosion

Ask the students if they have ever found leaves in their yard that came from a neighbor’s tree. Have the students explain how the leaves got there. Just as the wind carries leaves, it also carries and moves weathered rock. Question students as to if they have ever seen television programs that showed people walking in sand storms. Explain to students that the small pieces of sand are actually pieces of weathered rocks. Introduce the term *erosion*. Explain to the students that weathering and erosion work together to tear down some landforms while forming others in different locations. Use a map of Louisiana to show the Mississippi River Delta and explain to the students how the sediment that forms the delta is carried by the water of the Mississippi River. Ask the students to think of other natural agents of erosion that they may have observed at home. (They may suggest water running down their driveways, rain eroding hills, muddy water in ditches after a rain.)

Using a painter's pan, the students will model a riverbed. Press a layer of soil on the pan. Ask students, "If we make it rain on the land, what do you think will happen to the land?" Pour or spray water with a spray bottle near the highest part of the pan to mimic rain. Allow students to observe how the water can move weathered material downstream. Ask students what force is pulling the material down the hill (gravity). If the students do not know this, the teacher will introduce the term at this time. The students may question how the amount of incline of the pan affects erosion. Allow students to design an additional investigation to explore this idea. Students should present their methods of testing the hypothesis to the group and the group will determine the best design. After the students perform the investigation they should repeat the activity changing the incline of the pan to test the effect of steepness of the hill and water speed on erosion. The students will record the data in a table created in their science *learning logs*, make careful measurements of the incline changes, and draw conclusions. Students should conclude that the steeper the hill the faster the water runs down the land. The faster the water runs down the land, the more land the water can potentially erode.

Show students pictures of the Grand Canyon. Have students explain how the canyon became so deep. Ask students if this was a slow or fast process (slow). Show students aerial photos of the Louisiana coastline before and after Hurricane Katrina. Have students identify the differences in the pictures. (Students should note the significant amount of land loss associated with this storm.) Ask students if this was a slow or fast process (fast). In their science *learning logs*, students should summarize the elements of erosion that have been discussed and demonstrated. Instruct students to describe the ways that rocks or mountains can be eroded. The student should also conclude that the process of erosion can be both a slow process and a fast process.

Activity 2: Rocks I (GLEs: 7, 8, 9, 10, 55)

Materials List: chart paper, samples of rocks (igneous and sedimentary), construction paper of various colors, glue, illustrations of fossils, bread, jelly, hand lens, sand, safety goggles, disposable gloves, shells, salt, flour, water, sifters or screens, balance, hammer, jar with lid, Petri dish or shallow dish for evaporating, Internet access, science learning logs

Teacher Note: Some of the investigations will require prior preparation.

Introduce the rock cycle by discussing volcanic processes and the formation of igneous rock. Go to <http://www.ngdigitalmotion.com> and search the footage for volcanoes. This site contains short clips of close-up video of the vent of a volcano. Show the students the video and have students describe what they observe. Use chart paper to start a drawing that, when completed, will illustrate the steps of the rock cycle. Label the chart "Rock Cycle" and then draw an illustration to represent the volcanic process on the chart paper. Ask students what happens to the hot lava after it reaches the surface. (It begins to cool and harden.) Allow students to observe the samples of igneous rocks that are in the classroom rock collection. Examples are granite, obsidian, basalt, pumice, and scoria

(used for landscaping and in gas grills). Then prompt students to consider that weathering will begin as soon as igneous material surfaces. Add the term *weathering* to the rock cycle diagram.

Ask students what they think happens to the small pieces of rocks that are formed from the weathered rocks. Explain that weathered material is deposited into layers by agents of erosion (wind, rivers, and glaciers). The weathered material carried by the agents of erosion is called *sediment*. As time passes, these layers become compressed, or packed to form the hard rocks. The rocks that form from sediment are called *sedimentary rocks*. Ask students if they have ever seen rocks that contained smaller pieces of rocks or fossils. Sedimentary rocks often contain fossils. Add the terms *erosion* and *deposition* to the rock cycle diagram.

Assemble a set of sedimentary rocks for the students to examine. Examples of sedimentary rocks are sandstone, shale, conglomerate, limestone, coquina, etc. The students will model the formation of sedimentary rock layers by gluing different colored strips of construction paper to a whole sheet of construction paper. A rock type can be assigned to each color used. One color could represent a conglomerate rock (made from pieces of former rocks that are held together and are heavy and normally deposited near the shore). The student could draw pebble-sized chunks on the paper. Another color could represent sandstone which is made of small grains of sand. The students could put small dots on the paper. Within the shale layer of the model, the students can draw or glue teacher provided illustrations of different fossils, thus forming a fossil record. The teacher should ensure that fossil illustrations used would actually be found together.

Prior to the first gluing of a layer, the teacher could assemble a jelly sandwich to aid in the student's understanding that the bottom layer is the first one deposited. Instruct the students to label the layers of their model from the oldest (bottom) to the youngest (top). While the students glue each layer the teacher may explain how a catastrophic event like a volcano eruption might deposit a layer of ash, while river flooding may form a deposit of sediment such as sand or clay.

Ask students what they can use to observe rocks more closely (a hand lens). Allow students to observe the particle size of sedimentary rock samples using a hand lens. They should also observe the texture of the rocks. The students will define the terms *sediment* and *deposit* in their science *learning logs* ([view literacy strategy descriptions](#)) and explain how to determine the relative age of one sedimentary layer to another. Explain that each layer of sediment is covered and buried below other layers before the sediment will become rock. This process will take thousands perhaps millions of years to complete. Add the words *compaction* and *compression* to the rock cycle diagram and draw illustrations to represent these processes. Ask students what happens to the sedimentary rock once it is exposed to the weathering process. Add the word *weathering* to the cycle and draw an illustration to represent weathering. (Note the diagram is not complete at this time and will be added to later.) Have students write a brief summary in their science *learning log* explaining how sedimentary rocks are formed and where the particles that

form them originate. (Student responses should include some explanation that sedimentary rocks are composed of particles that result from weathering and erosion.)

Have students identify the safety precautions necessary when handling sand. (Wear safety goggles and disposable gloves.) Provide student teams with a pre-made rock-like material made of sand, shell, salt, flour and water which have been hardened at a low temperature in an oven. Ask the students to make careful observations of the rock. Direct students to use a balance to determine the mass of their sedimentary rock, draw it, and describe its appearance in their science *learning log*.

Break and pulverize the rocks with a hammer and return the broken material to each group the next day. The students will separate and classify the materials found in the rocks and label their groups of rock materials. Ask students what tools could be used to help them to separate the material (sifters or screens of different sizes). Have students use sifters or screens to further separate out their materials. The students will observe that some sedimentary rocks are made of pebbles, shells, and sand. Ask students how they could further separate the materials that are in the sand. Have them think about how sediments are deposited. The students should suggest adding water to the mixture. The students will mix some of the sand mixture with water in a jar or vial. Cover the jar and shake. The students will record all observations in their science *learning logs*. The students will illustrate the shaken mixture immediately. Then, the solution will be allowed to settle overnight. The students will observe the settled jars and illustrate and describe the layers. They will notice that the water has a yellowish appearance. Ask students how they can separate what is in the water from the water. They may recall the activity from Unit I where they separated salt from water. The students will pour some of the water in a Petri dish (shallow dish) and allow the water to evaporate. The students will observe salt crystals in the dish. Introduce salt as a mineral that is one of the components that may be found in some rocks. The students will list the materials that can be found in some rocks and conclude that minerals, which form crystals, are the building blocks of rocks.

Activity 3: Minerals (GLEs: 3, 9, 11, 17, 18, 19, 62)

Materials List: Louisiana mineral kit, samples of minerals, three different types of cookies, alphabet labels, pure samples of calcite, hand lenses, 1 set of each per group (penny, steel nail, square of glass, vinegar, dropper), Moh's Scale of Hardness BLM (1 per student), Mineral Sampling BLM (1 per student), science learning logs

Teacher Note: A sample Louisiana mineral kit can be obtained through the Department of Natural Resources. Keep this kit for display purposes.

Safety Note: Students should not eat the cookies they will be handling in this activity.

Introduce the terms *geology* and *geologist*. Begin with a sample of minerals ordered from scientific supply companies. Be sure that the set includes calcite, milky quartz, fluorite,

and gypsum. Explain that rocks and soils are composed of many minerals. Tell the students that they are going to be geologists, trying to identify rocks. Using their senses and hand lenses, the students will consider three types of cookies to show that all the various rocks are made from a few of the same common minerals. Just as cookies are made of flour, sugar, eggs, butter, etc.; rocks are commonly made of the minerals quartz, calcite, etc. and these minerals are made up of tiny particles of matter called elements. Some minerals, like gold or silver, are made of only one element. But most minerals and rocks are composed of many different elements. Like chocolate chip cookies, which are sometimes different - with nuts or not - different kinds of quartz are generally the same, but with different elements that affect its color. Ask them how they could tell what kind of cookies they were given (color, smell, taste, seeing certain ingredients). Tell them that geologists use many of those same methods to identify the components of rocks and soils.

The students will learn to describe five properties of minerals that will help them later in rock identification activities. Provide student groups with several mineral samples labeled with letters of the alphabet, for example sample A. Ask students to classify the minerals and explain how they classified them. Have students share their classifications, and create a list of properties the students used to classify the minerals. Explain what *luster* and *texture* mean and supply or generate from the students' descriptive words that exemplify each term (metallic, dull, shiny, rough faces, smooth faces).

The students will use hand lenses to observe color, luster, and texture for a number of samples. Discuss the observations and have each group discuss the likenesses and differences. Cooperatively create a Venn Diagram, a type of *graphic organizer* ([view literacy strategy descriptions](#)), of the samples based on the given characteristics. Since some minerals share similar characteristics, there may be other properties that can be observed.

Introduce the Moh's Scale of Hardness BLM to students. Explain to students that hardness is one of the properties scientists use to identify minerals. Model how to conduct a hardness test (Directions can be found at <http://www.rocksandminerals.com/hardness/mohs.htm>). Distribute a set of unknown minerals (labeled with letters for identification) to each group and a copy of the Mineral Sampling BLM. Each sample in the set should be tested for hardness by students and the data recorded in the table. Number the minerals from softest to hardest with 1 being softest, 2 the next hardest, and so on.

Introduce the effervescence test or bubbling test for calcite. Taking a pure sample of calcite, place the sample in vinegar (acetic acid) and allow the students to observe the bubbling. Place a few drops of vinegar on each mineral sample. Observe the sample for steady bubbling. (Note: A few bubbles can indicate the release of trapped gas and not calcite which reacts with acid to form carbon dioxide.) Place the results in the data table. Using the data again, the students will compare the minerals. Read the characteristics for each mineral and have the students identify which sample is that particular mineral. Students will describe the observations that are used to identify minerals in their science

learning logs ([view literacy strategy descriptions](#)) and will explain why different tests are needed.

The teacher will facilitate a discussion of the criteria students used to categorize their information.

Activity 4: Rocks II (GLEs: 1, 2, 3, 9, 10, 55, 62)

Materials List: samples of rocks (sedimentary, metamorphic, and igneous); loose-leaf paper; one per group -vinegar, dropper, hand lens; teacher-selected resources on uses of Earth materials, science learning logs

Part A: Revisit the classroom chart of the rock cycle begun earlier. Review the processes that created igneous rocks and sedimentary rocks. Explain that sometimes both igneous rocks and sedimentary rocks are pushed down near the mantle which causes the rock to change, or metamorphose, under great pressure and heat. This third type of rock is called *metamorphic rock*. Add that rock to the classroom rock cycle diagram and draw an illustration to model the metamorphic process. Ask students what they think happens to metamorphic rock once it is exposed to the weather. Tie the metamorphic rock illustration to weathering and erosion in the diagram.

Part B: Using a rock collection or kit which contains sedimentary rocks such as limestone, sandstone, marble, and granite, and other igneous rocks, students will classify the rocks through observation of similarities and differences in color, surface texture, general descriptions including size of visible crystals and air holes, luster, and hardness. Ask students what questions they might have about the rocks (name, type, where they came from, how formed). Ask the students what they could do to find out what minerals are in the rocks (hardness test, effervesce test, color, the way they break at the edges). Students will record all information in a data table in their science *learning logs* ([view literacy strategy descriptions](#)). Students will make careful observations of the rocks and perform the hardness test. Using vinegar, a dropper, and a hand lens, the students will perform the effervescence test to determine if the rocks contain the mineral calcite. The calcite test is sometimes a determiner of whether the rock is a non-igneous rock since many sedimentary rocks and metaphoric rocks are made from sedimentary rock containing calcite. (Generally sandstone and shale will not bubble as calcium carbonate may not be present.) The students will then determine that limestone and marble contain calcite. Because rocks are composed of different percentages of minerals there are samples that sometimes exhibit characteristics not commonly observed in the general grouping. It is important to note that the term *sand* refers to a particular particle size, not a particular mineral. Most often people think of sand as silica (which will be very hard when tested for hardness) but there are magnetic sands, sands cemented with calcium carbonate (which will effervesce), white gypsum sands (which will be very soft), and some beach sands that are made from shell particles.

Ask students if they can, at this point, be sure which rocks are sedimentary or igneous. Give students these clues: Sedimentary rocks are usually made of the same kind of particle cemented together; igneous rocks have large crystals from slow cooling or gas holes when cooled in the presence of air.

Students are to revisit their data tables and to try to classify their collected rocks into the three types of rocks. Students should work in groups and discuss their results. Confirm their predictions that sandstone and limestone are sedimentary, marble is metamorphic rock made from limestone, and that granite is an igneous rock.

Part C: Separate students into groups of 4 or 8. Have the students develop a science *story chain* ([view literacy strategy descriptions](#)) about the life of a rock as it travels through the rock cycle. Students are to write the story from the point of view of the rock. The science *story chain* should begin at any point in the rock cycle and give information about the changes the rock is undergoing at each stage. Give each student one sheet of paper. Each student will write the opening sentence of his/her rock cycle *story chain*. The students will then pass their paper to the student in their group sitting to their left, and that student writes the next sentence in the story. The paper is again passed to the left and that student writes the third sentence. The paper should be passed to the next student until a sentence has been written about all stages of the cycle.

Example Story Chain

Student one: Today I burst forth in a wave of hot lava from a volcano.

Student two: I began to cool off quickly and harden.

Student three: Year after year the rain has pounded down on me, finally breaking me into small pieces.

Student four: The rains came today and carried me away, down a swift river, and out into the ocean.

Student one: New pieces of rocks are raining down on me everyday and the pressure on me is becoming great.

*** Students will continue to add sentences until all story chains are complete.

Students should take turns in their groups reading their story aloud. All group members should be prepared to revise the story if the information was not clear or incorrect. Have students use their story to create a rock cycle book. Illustrations can be included in their books. Students can share their books with other students in lower grades.

Activity 5: Properties of Soil (GLEs: 1, 2, 4, 10, 13, 17, 56)

Materials List: safety goggles, disposable gloves, hand lens, 1 of each per group (soil samples, ruler, paper plates, distilled water, plastic cup, graduated cylinder, red cabbage juice indicator or pH paper, empty water bottle), empty seed packs, jars, Soil

Permeability Sampling BLM (1 per group), Soil Sampling BLM (1 per student), science learning logs

Safety note: Provide students the opportunity to suggest what safety precautions should be undertaken while studying the soil samples. Safety glasses should be used, disposable gloves should be worn, and careful washing of hands should follow the lab.

Part A: Introduce this activity by asking students what they think soil is made of? (Answers will vary.) Students should come to an understanding that soil includes weathered rock material called sand, silt, and clay—terms which refer to sizes of the material. Soil also includes air spaces, water, and decaying organic material (humus). Give students small samples of clay, sand, silt, and potting soil on a paper plate. Using the Soil Sampling BLM, instruct them to describe the characteristics of the soil including color, smear (smear onto paper), texture, odor, presence of visible organic matter, stickiness (the ability of the soil to be rolled into a ball after a few drops of water are added), and permeability. Describe what the terms *texture*, *organic*, and *permeability* mean. The students will observe the soil samples using a hand lens. Since the texture must be observed without gloved hands, they will need to wash their hands after the lab is over. After making the first five observations listed above, aid the students in slightly wetting the soil samples to observe if the soil can be rolled into a ball. The students will discuss their observations and compare the samples.

Part B: Ask students to predict which soils they believe would make good growing media for plants and why. Discuss with students a plant's basic need for water. Refer students back to the acronym LAWNS learned in Unit 4, Activity 2 to help them remember the basic needs of plants. Discuss what happens to a plant that receives too much water and what happens to a plant that receives too little water. Explain to students that soil permeability is the ability of water to flow through a soil. To test the permeability of the soils, students will put a measured amount of each soil sample in plastic cups which have holes punched into the bottom. On the Soil Permeability Sampling BLM, ask students to predict what will happen when water is added to each sample. Add a measured amount of water to each cup. Record this information into the chart and observe how long it takes for the water to stop dripping from each cup. Discuss whether students' predictions were correct, and if not, why not? Students should discuss the merits of each soil type for growing plants, based on the soil's permeability.

Students may also test the pH of the soil by using red cabbage indicator, <http://www.vickicobb.com/scienceyoueat.html> or pH paper. If using pH paper, place the paper into a solution of the soil and distilled water. Demonstrate how to read the indicator.

Part C: Remind students that eroded soil is carried by rivers. In Louisiana, many rivers have flooded and deposited soils eroded from different areas of the country. Students should begin to wonder what kind of soil can be found in their neighborhoods. Ask the students what type of Earth materials could be carried the farthest, heavier large pieces of material or lighter small pieces of material. (Have them recall the settling activity from

Unit 1. Students may suggest that heavier or larger sized particles may fall out first.) As a teacher demonstration, half fill a jar containing soil with water. Before shaking it, observe air bubbles rising through the water. Ask students what this is evidence of? (Soil contains air. Generally the more organic material the more air the soil will contain because it is less tightly packed.) In small groups, allow students to put a mixture of clay, sand, gravel and silt in an empty water bottle. Students will predict which material will fall out of suspension first and record their predictions in their science *learning logs* ([view literacy strategy descriptions](#)). Fill the bottle with water. Shake until all the material is mixing with the water in the bottle. Using a ruler, instruct students to measure the layers after five minutes and 20 minutes. Allow the jar to settle overnight and measure again. Look for floating organic material. The soil sample will form layers of gravel, sand, silt, and clay. The clay will probably be held in suspension the longest. Students should compare the results to their predictions. The students will draw a diagram of the sample in their science *learning logs* and label each layer. If the clay remains in suspension, students' drawings should so indicate.

Part D: Discuss the importance of the organic material (humus) in forming rich productive soils and what happens when it is lost. Students may research the causes of the Dust Bowl. Students should also be asked to draw conclusions about how soils may influence where people can grow crops (areas with adequate drainage, humus), plant pine forests (in sandy soil), and create rice and crawfish farms (clay foundations help to hold water). Invite a representative from the local Soil Conservation District office or county agent to speak about soil conservation, if possible.

Activity 6: Water Cycle (GLEs: 1, 2, 4, 7, 10, 11, 18, 38, 58)

Materials Lists: 1 set per group (2 jars with lids, water, tape, graduated cylinder, markers, 2 coffee cans with lids, garden soil, black construction paper), science learning logs

Refer to or repeat the activity from Unit 1 which demonstrated evaporation and condensation or do the following activities.

Part A: Evaporation

To model and develop the concept of *evaporation*, the students will pour 0.5 liter of water into each of two jars with lids and mark the water levels. Cover one jar and place both in a sunny window. For teachers without classroom windows, jars may be placed under a heat lamp. Students will observe and mark the water levels each day and record their observations in a data table in their science *learning logs* ([view literacy strategy descriptions](#)). Students will explain why there is a difference between the water levels in the two containers after a period of time. Where has the water gone? Is there evidence of evaporation in both containers? (The condensed water on the lid is a clue.) Students should identify the water collecting on the lid as precipitation that falls back into the container.

Part B: Condensation

Safety Note: All sharp edges on the can should be covered with tape.

Ask students to define *evaporation* and *condensation*. To model condensation, the students will fill a can half full of garden soil, covering the can with black construction paper and placing a plastic lid on the top. A control can without the soil should also be prepared with the black construction paper on the outside and a plastic lid placed on top. Put the cans in a sunny window, outside, or under a heat lamp. Water droplets will begin to form on the underside of the lid covering the can that contains soil. Ask students what variable was changed between the two cans. Ask students where the condensed water is coming from (the soil). Explain that soil is composed of weathered rock, air, water, and organic material. As the water droplets begin to coalesce and get heavy, they will fall back to the soil, similar to precipitation in the atmosphere. Ask students what force is causing the heavy water droplets to fall down toward the soil (gravity). Students will relate this model to the water cycle and realize that water trapped within the soil is part of the water cycle and very important to plants. Have students recall that water can pick up acid from decaying material in the soil and weather limestone formations under the ground. The students should diagram the water cycle in their science *learning logs* and write a paragraph explaining the process.

Ask students to think how the water cycle relates to the rock cycle (weathering, erosion, and deposition) and to write a paragraph developing the relationship between the two cycles in their science *learning logs*.

Activity 7: Weather Station (GLEs: 4, 6, 7, 8, 9, 10, 20, 57, 59)

Materials List: 1 set per weather station (empty milk carton, jar, cut plastic bags, non-mercury thermometers), masking tape, scissors, poster-sized charts, 1 per student group (large jar, 2 sheets of black construction paper, cardboard or plywood, books, soil, water, heat lamp, 100 watt light bulb, 2 - 250 ml beakers, 2 thermometers), towels or pillows, 1 set for demonstration (10 gallon aquarium, heat lamp with clamp, 100 watt light bulb, ice, bowl, punk, plastic wrap, matches), Weather Data Collecting BLM, (one per student), How Angle Spread Sunlight Data Table BLM (1 per student), science learning logs

Part A: Ask students if they have ever seen weather forecasts on television. Introduce the term and describe the job of a meteorologist. Ask students what kind of weather information the meteorologist provides and how the class could gather information on the daily amount of rainfall and other weather data such as wind direction, wind speed, and wind pressure. Allow students to research and design weather instruments from available material of their choice to be used at school and at home. A good resource to use for locating instructions for building weather instruments is <http://www.fi.edu/weather/todo/todo.html>. Data should be compiled and averaged daily. The students should create a weather center for the classroom or school (check with

principal to determine best location, etc.) that may include traditional weather tools and the student-made ones. Lead the students to an appreciation of the need for precision when creating instruments so that accurate data can be collected.

During the school day, the rainfall will be measured, wind direction will be determined, and wind speed will be estimated using the Beaufort scale (found at http://www.zetnet.co.uk/sigs/weather/Met_Codes/beaufort.htm) or from a simple student-made anemometer. Temperature will be gathered using a thermometer. (Directions on making weather tools can be found in various books and on the site <http://www.fi.edu/weather/todo/todo.html>.) Each student will record all measurements daily on the Weather Data Collecting BLM. The students will define and use weather terms such as *precipitation*, wind direction terms such as *easterly* and *westerly winds*, and descriptive terms such as a *gentle breeze* and *gale force winds*.

Students will collect, record, and graph the data in both metric and U.S. units. Students will make predictions based on the data. The students will produce daily and weekly weather data poster-sized charts for the classroom. If computers are available, students may refine their predictions based on the use of NOAA satellite images and weather data from states nearby.

Part B: Prior to this activity, instruct students to use a newspaper listing or to conduct an Internet search to locate temperatures of five cities around the country and the world. The students should observe that the temperatures vary and give reasons as to why the temperatures are different. (Some may state that areas are farther from the equator.) Tell them that they will learn a little more about this later in the activity.

Probe students as to the cause of the differences in air temperatures. To model how the amount of light hitting each area of the globe affects air temperature, have students complete the following activity: Instruct students to cut an inch-wide slit in the middle of each piece of black construction paper. Tape one sheet of black construction paper to each of the cardboard or plywood boards. Place a thermometer into each slit such that the bulb is between the board and the paper, and the scale can be read without removing the thermometer. Tape the thermometer in place. Leave the assembled thermometers in the shade long enough so that they read the same outside temperature. Use books to tilt one board so that it faces the Sun and the Sun's rays fall nearly perpendicular to the board. The other should be flat on the ground or even tilted slightly backwards from the Sun if the Sun is especially high in the sky. Instruct students to record the temperature on each thermometer every minute on the How Angle Spreads Sunlight Data Table BLM until the temperatures level off and stop climbing. Allow the thermometers to remain undisturbed for a few minutes then record their final temperatures. Present students with the following questions and have students record the answers.

- Which paper was heated more quickly?
- Which got warmer?
- What do the results of this experiment tell you about the changes in temperature?
- What was the angle of the Sun when the temperature dropped?
- What was the angle of the Sun when the temperature was the highest?

The students should conclude that the more direct the Sunlight, the more energy an area receives.

Part C: Ask the students if they know what causes wind. Ask if they know anything about the movement of cold and warm air. (Some may say that hot air rises as they have seen hot air balloons lift off, smoke rise, or identify the waves of heat coming off road pavement or the surface of a car in the summer.) The teacher should be sure to point out that the hot air is less dense than the air that surrounds it. If access to the LPB Cyberchannel is available, show students the video *Weather Smart: Heat, Wind, and Pressure*.

Refer students back to the previous activity and ask students how this uneven heating could affect the winds and have them record their ideas in their science *learning logs* ([view literacy strategy descriptions](#)). Create a model of the Earth to help demonstrate how the uneven heating of Earth's surface creates wind. Insert a 100 watt light bulb into a clamp light socket. Place the lamp so that it shines 8 centimeters from the edge of one end of a 10 gallon aquarium. In the other end of the aquarium, place a bowl full of ice about 8 centimeters from the edge. Cover the aquarium with plastic wrap. Light the end of a punk and allow it to burn for a few seconds. Blow out the punk and use it to puncture a small hole in the plastic wrap near the bowl of ice. Have students observe the model and in their science *learning logs*, describe what happens to the smoke. (It circulates. The warm air near the lamp circulates toward the area of the aquarium with the ice, and the cool air near the ice circulates toward the area of the aquarium with the lamp.) Discuss with the students the difference in the temperatures of each end of the aquarium. Guide students to explain how this uneven heating caused the smoke to circulate through the aquarium. This model is similar to what happens to create wind on Earth. Note: There should also be layering, i.e., warm air on the top and cool air on the bottom. The teacher should illustrate this as well.

Next, have students investigate whether land or water changes temperature faster. Have students place 150 ml of soil in one 250 ml beaker and 150 ml of water in another 250 ml beaker. Direct students to create a data table in their science *learning log*. Place a thermometer in each beaker and record the initial temperature. Place the heat lamp about 10 centimeters from the beakers, ensuring that each beaker is equal distance from the lamp and both are receiving equal amounts of light. Turn on the heat lamp. Record the temperature of each beaker every minute for ten minutes. Turn off the lamp and record the temperature every minute for ten minutes. Have students analyze their data. Have students determine whether further investigations are needed to draw valid conclusions. Hold a class discussion about the results. The students should conclude that land heats and cools faster than water. Explain to students that the temperature of the air above the land and the water is affected by the temperature of the land and the water.

Explain to students that a real-life example of this uneven heating is the temperature difference between the coastal areas and areas in central Louisiana. Have students research and record the land temperature and wind direction in the morning and at night

of two cities near the coast of Louisiana and two in central Louisiana. (Of course, there are other factors such as weather fronts that may have to be considered.) Students should note that areas near the coast are warmer than areas inland during the daytime. (This is generally the case of the north and south shore of Lake Pontchartrain.) Ask students to explain why (the warming effect of the water). Students should also note that the wind blows inland (sea breeze) during the daytime and offshore (land breezes) at night near the shore. Guide students to explain why. (Since the air over land cools more rapidly at night than the air over water, a temperature difference is established, with cooler air present over land and relatively warmer air located over water and vice versa for daytime. This uneven heating of air causes wind.)

In their science *learning logs*, have students summarize what they have learned about the unequal heating of Earth's land and water and how this creates wind on Earth.

Activity 8: Weather Phenomena and Safety (GLEs: 10, 12, 60, 61)

Materials List: polyethylene sheet, metal pan, clay, metal object, teacher-selected resources on weather phenomena, posters, markers or crayons

Teacher Note: This activity may not work well on a humid day in Louisiana.

Tell students that today they will be studying different kinds of serious weather events. Ask them if they can determine which weather event you are demonstrating. Demonstrate lightning by using the following demonstration of static electricity. Rub a polyethylene sheet with a metal pan that has a clay or putty ball attached as a handle. Rub the sheet for a minute. Then, in a darkened room, place the pan next to a metal object. A spark should discharge from the pan. Ask students what weather event the spark brings to mind. Ask students if they have experienced static discharges before and how they happen naturally. Display images of cloud-to-cloud, cloud-to-ground, and single cloud-lightening strikes. Students may have stories to share about lightening strikes to buildings or trees.

The students will name other weather events of which they have previous experience and/or knowledge. The students will use teacher-selected resources to learn about the causes of lightning and thunderstorms, hurricanes, and tornadoes. They will research the National Weather Service warning alert system and the safety measures to be taken in the event of hazardous conditions. The students will make posters and presentations to the class describing the weather event.

Students will *brainstorm* ([view literacy strategy descriptions](#)) a list of items that should be included in a family storm safety kit (batteries, medicines, first aid kits, medicines, flashlights, etc.) Hold a class discussion where students share their ideas and create a class list. Students should also list safety phone numbers that are needed in times of emergencies. Some parishes have emergency alert centers that are good resources for this information. Have students create a storm safety brochure that can be distributed at school, PTA meetings, etc.

Activity 9: Earth's Motions: Day /Night and the Seasons (GLEs: 1, 2, 3, 4, 11, 18, 66, 68)

Materials List: 1 set per student group (polystyrene foam ball, pencils, lamp or overhead projector, string, bamboo skewer, graph paper, clip boards, masking tape, flashlight, color pencils), map of United States, globe, science learning logs

Prior to this activity, be sure that the students understand that the rotation of Earth on its axis causes night and day. Ask students to contrast the usual temperature differences that occur during the day with those at night. Ask them why the temperatures drop after the sun sets. (The sunlight provides us with energy.) Have students model Earth's rotation using a polystyrene foam ball held in front of a lamp or overhead projector. The lighted side should be identified by the student as daytime and the side without direct light should be identified as nighttime.

Ask students to think of questions that they may have regarding the seasons. (Students may wonder why seasons happen, if all places have the same seasons, etc.) Ask students to name the seasons and to describe the changes in the weather and the environment that they have experienced during each season. Ask students if anyone has lived in a different part of the country or visited relatives in another state. Locate those places on the map. Have them share any information about the seasons in those locations.

Inform the students that the seasons are related to Earth's *revolution*, or trip around the Sun that occurs in a year, and its *tilt*. Since we cannot go into outer space to observe the movement of Earth, ask students what would be a good way to set up a science inquiry to observe the event within a classroom (make a model). Students will use the polystyrene foam balls found at craft centers as a model of the Earth. Attach a string around the center of the ball to represent the equator and insert a bamboo skewer through the center of the foam ball to represent the north and south poles. Discuss the meaning of the *equator* and the meaning of an *axis*. Position the ball on the pencil to represent the planet tilted on its axis. Help the students to tilt the ball at a 23-degree angle. Use a globe as a model. First, instruct the students to hold the Earth model with the axis perpendicular to the floor in front of a lamp to represent the Sun. Move it around the lamp as if in orbit. Guide students to note that the light strikes Earth's different hemispheres equally.

Ask students to predict what would happen to the area if the planet were tilted on its axis. To model how the angle of a surface affects how light spreads out, have students complete the following activity in small groups. Attach a sheet of graph paper to a clip board with masking tape. Hold the board perpendicular to the floor and shine the flashlight directly onto the graph paper about two feet away. (Be sure the flashlight is parallel to the floor, and, therefore, perpendicular to the paper. Trace the outline of the flashlight's beam on the graph paper. Keeping the same distance from the paper to the flashlight, rock the board towards and then away from the flashlight. Observations should be recorded in their science *learning logs* ([view literacy strategy descriptions](#)). Tilt the board at a large angle like 45° or 60° and trace the new outline of the beam with a

different color. Try a couple of other angles, marking the outlines with different colors. Count the number of squares colored or partially colored for each angle. Have students draw conclusions about how the angle of the surface affects how the light spreads out. (Students should conclude that more area is covered by the beam when the board is tilted at larger angles.) Explain to students that when the same amount of light is spread over a larger area then the intensity of the light decreases.

Instruct the students to hold up their pencil models so that Earth is tilted on its axis. Place the model so that the students will observe that the light is now slanted as it reaches the surface. Have students move the Earth model into positions that would represent the beginning of the four seasons, pausing in each position to observe which hemispheres are receiving more direct sunlight and those that are receiving less direct sunlight. Carefully observe the students while they move the Earth models through the seasons to make sure that the tilt of the axis remains parallel to its starting position. Have students note when the poles are in darkness. Instruct the students to rotate the pencil to observe day and night. Have them observe whether the rotation affects the areas that are in total darkness or light. Ask students how the amount of light an area gets could influence its weather and climate. (Sunlit hours would be affected which would affect the temperatures.) As the students move their models, name the seasons that the students are observing on the model. The students will also note that the illumination of the Earth forms equal parts on the model at the beginning of the fall and spring. (The equinoxes are periods of equal day and night across the globe.) The students should be instructed to observe that the illuminated parts of the Earth change as the Earth's position in its orbit changes. Ask them to recall the illumination at the beginning of the activity when the Earth was not tilted. Ask the students if the area of light would change from season to season if the Earth were not tilted. (Allow them to model this again if needed. They should conclude that the Earth's tilt influences the seasons.)

Discuss Earth's revolution around the Sun, the tilt of Earth, and their relationship to seasons. Aid the students in diagramming the Earth's orbit including the Earth illustrated in four locations to represent the illumination areas for the beginning of the four seasons. The students will label the diagram with the dates of the beginning of each season and the names of each season for both hemispheres.

Activity 10: Phases of the Moon (GLEs: 1, 2, 4, 10, 64, 66, 67)

Materials List: Blank Moon Calendar BLM (1 per student), store bought calendar (one with Moon phases included), flashlight or lamp, mirror or bicycle reflector, globe or ball, 1 set per group (polystyrene foam ball, black marker, pencils, cards numbered 1-8), Moon Phases BLM (1 per student), 1 set per student (yellow construction paper, glue, Moon phases illustrations, paper plate, markers, paper arrows, gold brads)

Part A: At the start of this unit, ask students to begin watching the Moon. Provide each student with a copy of the Blank Moon Calendar BLM and take the students outside on a

clear day when the Moon is visible in the sky. Have the students sketch the Moon as it appears in the sky and note the time of their viewing on the correct date on the calendar. On the following day at the same time take the students outside and ask what differences they notice between the appearance of the Moon, its location in the sky, and any other information they recorded the first day.

Ask students to look for the Moon every day for the next few weeks. They should draw what they see and record the time on the calendar square. For those students living in areas where it is difficult to observe the sky because of street lights or poor weather conditions, a newspaper, weather website, or at <http://imagiware.com/astro/Moon.cgi> or other sites suggested in the resources can be used to record the Moon's phase. The students should also prepare a classroom Moon calendar as a visual record that all might share and use to make predictions the following month. Compare what is drawn daily on the individual Blank Moon Calendar BLM to the identified Moon phases on a store bought calendar to what is observed in the sky, or to the newspaper or web resources above. Students should begin to look for monthly patterns. Have students notice the number of days in a complete cycle of phases. (They should conclude that a calendar month is based roughly on the Moon cycle). Ask students if they have a hypothesis as to why the Moon is often seen in the sky. (They should hypothesize that the Moon must be orbiting the Earth.) Explain to the students that both Earth and the Moon are orbiting the Sun which has a greater gravitational pull than the Earth. Further explain that because of how close the Moon is to Earth the gravitational attraction between them causes one side of the Moon to be locked in position facing Earth. (The Moon is actually slowly moving away from Earth at a rate of a couple of centimeters each year.) Students will prepare a diagram showing the Moon orbiting the Earth and the Earth orbiting the Sun. Remind students that this is a static model. Actually Earth is always moving forward in space as it revolves around the Sun.

Part B: Ask the students which side of the Moon's surface is facing toward the Sun. (The side that is lighted.) Ask the students why that part of the Moon is lighter. The students should state that the lighted part of the Moon that we see is reflecting light from the Sun. As the observation period continues, ask students if they have any questions about the Moon phases that they are recording on their Blank Moon Calendar BLMs. Students may wonder why the amount of light changes during the month and if the light comes from the Moon since they have previously learned that Sun lights Earth. To help them understand that the Moon is not a source of light, but a reflector of the Sun's light, the student can use a flashlight or lamp (Sun), a mirror or bicycle reflector (Moon), and a globe or ball to represent Earth. The students will reflect the light of the flashlight onto a mirror and move it until the light shines on the model of the Earth. The students will discuss that the mirror does not have a light of its own, but is merely a reflector of light just as the Moon is a reflector of the Sun's light toward our Earthly eyes.

Teacher Note: It is important that the students understand that 50 percent of the Moon is always lit by sunlight just as 50 percent of Earth is always receiving sunlight.

Encourage the students to recall the changing appearance of the light of the Moon throughout the previous weeks. The students should relate the change in the amount of lighted surface seen from Earth to the position of the Moon in the sky. Color half of a white polystyrene foam ball black for each group. Have students stick a pencil through the bottom of the ball so that the right side of the ball is black and the left side of the ball is white. Explain to students that the black side represents the side of the Moon opposite the Sun and the white side represents the side facing the Sun. Tell students that they will use their Moon models to demonstrate the phases of the Moon.

On the floor, place cards labeled “1” – “8” to mark stations 1-8, beginning with “1” at 12:00 and rotating to the right. Card “2” should be halfway between 12:00 and 9:00. Card “3” should be at 9:00, etc. All three students should line up in a straight line, with the Sun first, then the Moon (at station 1 -12:00) and finally the Earth (in the center of the circle created by the stations).

Begin by having the first student hold up a Sun made of yellow construction paper. The second child faces the Earth and will hold the Moon model with the white half facing the Sun. This first station will represent the new Moon phase. The third child will face the Moon and the Sun and will record their observations on the Moon Phases BLM. In the first box of the Moon Phases BLM, have students draw a picture of what they see on the Moon model (a circle shaded completely). This first drawing will represent the new Moon. Next, have the Moon rotate to the right to station 2. (Make sure that the Moon student always holds the white side of the ball completely towards the sun as he rotates.) Have the Earth student draw the image of the Moon they see at station 2. (The right side of the circle should be a white crescent and the rest shaded black.) Now instruct the Moon student to continue to rotate through stations 3-8 while the Earth student draws the image seen by the Moon model.

Have the students switch positions and repeat the procedure until all students have completed the Moon Phases BLM.

After all students rotate through the cards, have students share their drawings and create a class chart of the Moon phases. Using the class chart, introduce the terms and meaning of *waxing*, *waning*, and *phases*. A good memory clue is to think of waxing as lighting a wax candle in that the light on the Moon increases and waning as the draining of light off of the Moon. Label all the phases of the Moon on the class chart and have the students label their Moon Phases BLM.

To further reinforce the vocabulary, students can prepare a Moon clock by gluing prepared Moon phases on a paper plate. Using markers, the left half of the rim of the plate from the new Moon to the full Moon can be colored yellow and labeled “waxing,” and the right half from the full Moon to the new Moon can be colored blue and labeled “waning.”

During the activity, the students should begin to conclude that the phases of the Moon are a result of the amount of light being reflected off of the Moon toward the Earth’s surface,

and that the shape of the reflection is a result of the relative positions of the Moon, Earth, and the angle of the light reflecting as the Earth revolves around the Sun and the Moon revolves around the Earth. The students will examine traditional diagrams of the Moon phases and interpret the diagram based on the investigation.

The students will return to their Moon plate and add the additional prepared cut-out phases—waxing crescent, waxing gibbous, waning gibbous, and waning crescent—to their plate model. Placing a paper arrow attached to a brad in the center of the plate will provide the student with a Moon calendar that can be used as a study guide and as a phase calendar for the rest of the year.

Activity 11: Eclipses (GLEs: 2, 3, 4, 10, 18, 64, 65, 66, 67)

Materials List: Cat Stevens' Song *Moon Shadow*, polystyrene foam ball and pencil (1 per student pair), lamp, science learning logs

Safety Note: Students should be cautioned against looking directly at the light source being used to represent the Sun in this activity.

In preparing for this activity, the teacher should research if there will be any observable eclipses during the school year. If available, students will listen to a short version of Cat Stevens' song *Moon Shadow* or the teacher can read the words to the song aloud. Previously, they may have thought of the Moon as being a reflector of light and not an absorber of light. Ask students to explain how an object can cause a shadow and what type of object produces a dark shadow (opaque solid). Ask students if the Moon can cause a shadow and what the song writer is telling us about the composition of the Moon.

Using the small polystyrene foam ball from Activity 10, a lamp, and your students, guide student to understand the process that creates eclipses. Ask the students if they can define an eclipse and if they know the difference between a solar and a lunar eclipse. Explain to students that we can understand eclipses by looking at models of the Sun, Moon, and Earth. Place a lamp (without a lampshade) on a desk at the front of the room and turn it on. Darken the room as much as possible. Have the students stand in a semicircle facing the lamp, holding their Moon models at arm's length. Explain to them the light represents our Sun, the polystyrene foam balls the Moon, and the students' heads our Earth. Have the students move the balls around their heads to model the rotation of the Moon around the Earth. Have them move the Moon ball in orbit until it completely blocks their view of the Sun/lamp. Ask students to describe what they see. Explain to them that when the Moon is positioned between the Earth and the Sun, a solar eclipse occurs. Have students draw a diagram in their science *learning logs* ([view literacy strategy descriptions](#)) of the position of the Sun, Moon, and Earth during a solar eclipse and label the parts.

Propose the question: If a solar eclipse happens during the day, when do you suppose a lunar eclipse would occur? Have the students turn their backs to the sun and position their

ball so it's directly opposite the Sun, with their head casting a shadow onto the ball. Ask students to describe what they observe. Explain that when the Moon passes into the Earth's shadow, we have a lunar eclipse. Have students draw a diagram of the position of the Sun, Moon, and Earth during a solar eclipse and label the parts in their science *learning logs*. Ask students if more people see a solar eclipse, or a lunar eclipse? Have your students watch the sizes of the shadows for each to decide. Have them look at a partners face during their solar "eclipse". How big is the shadow that falls on their face? Then repeat for the lunar "eclipse". Have students research how often an eclipse occurs and why lunar eclipses do not occur every month.

Discussion: Does an eclipse of the Moon happen every month? Every year? How could you find out when the next eclipse will occur?

Activity 12: From Telescopes to Space Probes: (GLEs: 11, 69)

Materials List: Galileo's Drawings of the Moon, encyclopedias, satellite images of weather, teacher-selected resources on space exploration and space observation technology

Students will research the advances made in space exploration and space observation technology and record their research in their science *learning logs* ([view literacy strategy descriptions](#)). Have students share their information during a class discussion. Students should try to gather drawings and photographs of various planets, their moons, and Earth's Moon. If available (The drawings can be found on http://www.pacifier.com/~tpope/Moon_Page.htm) provide the students with Galileo's drawings of the Moon as he observed it through the first telescope he made. (The drawings are often found in biographical information of Galileo.) Compare those drawings to present day photographs of the Moon. Using older encyclopedias found in most libraries or older books on space and more modern books and online NASA images, the students will compare the older images to those taken recently to observe the advancements in imagery made possible by new technology. The National Weather Service, NOAA, and NASA all have websites that can be used to gather satellite images of weather, ocean temperatures, and other remote sensing images. Students should also observe satellite images of weather.

Assign students a short report on the Space Station, Hubble Telescope, Voyager, Pathfinder and the Sojourner probe, Galileo, Apollo 11, or other space missions. The students will write a short report containing an illustration or photograph that represents the mission and explaining how the mission has advanced our knowledge of the universe. Have students present their reports to the class.

Sample Assessments

General Guidelines

Assessment techniques should include use of drawings/illustrations/models, laboratory investigations with reports, laboratory practicals (problem-solving and performance-based assessments), group discussion and journaling (reflective assessment), and paper-and-pencil tests (traditional summative assessments).

- Students should be monitored throughout the work on all activities via teacher observation of their work and lab notebook entries.
- All student-developed products should be evaluated as the unit continues.
- For some multiple-choice items on written tests, ask students to write a justification for their chosen response.

General Assessments

- Complete a word puzzle of key vocabulary words using rocks, mineral, and erosion/deposition themes.
- Keep a record of weather predictions.
- Make a presentation of the daily weather report.
- Prepare a soil profile.
- Correctly label an illustration of the water cycle.

Activity-Specific Assessments

- Activity 2: Given a set of basic rocks, have students classify the rocks as igneous or sedimentary.
- Activity 9: The student will label a diagram of the Earth's orbit showing the correct locations of the Earth at the beginning of each season in the Northern Hemisphere. The student will explain how the Earth's location in its orbit and the tilt of the Earth create the seasons.
- Activity 10: The student will sequence a series of Moon phases in the correct order and label them as "New Moon," "Waxing Crescent," "First Quarter," "Waxing Gibbous," "Full Moon," "Waning Gibbous," "Last Quarter," and "Waning Crescent."
- Activity 11: The student will correctly label appropriate diagrams illustrating the lunar eclipse and solar eclipse.

Resources

- *Earth's Crust/Rocks and Soil*. Video. Bill Nye Science Series. Disney Educational Productions. 1995.
- *Magic School Bus Inside the Earth*. Video. Scholastic Productions, Inc.
- Gibbons, Gail *Weather Words and What They Mean*. New York: Scholastic, Inc., 1990.
- *Investigating Science Weather The Mailbox*. Greensboro, NC: The Education Center, Inc., 2000.
- Taylor, Barbara *Weather and Climate*. Kingfisher Books, 1993.
- VanCleave, Janice. *Weather*. New York: John Wiley and Sons, Inc., 1995.
- *Weather: Air in Action*. AIMS computer software
- Wood, Robert W. *39 Easy Meteorology Experiment*. Science for Kids. Blue Ridge Summit, PA: Tab books, 1991.
- *Investigating Science Solar System. The Mailbox*). Greensboro, NC: The Education Center, Inc., 2000.
- <http://coastal.er.usgs.gov/hurricanes/katrina/photo-comparisons/chandeleur.html> - photos of La. coastal changes before and after Katrina
- http://en.wikipedia.org/wiki/Mississippi_River_Delta - map of Mississippi River Delta
- *Moon Mania* Available online at <http://www.lpb.org/education/classroom/MoonMania/>
- <http://cleardarksky.com/c/HghLndRdObLAkey.html> - provides links to current sky data for Louisiana
- Moon phase calendar-- <http://tycho.usno.navy.mil/vphase.html>
- http://www.calculatorcat.com/Moon_phases/Moon_phases.phtml - Moon phase calendar and phases descriptions with pictures
- <http://www.r-p-r.co.uk/beaufort.htm> - Beaufort wind scale
- <http://www.rocksandminerals.com/hardness/mohs.htm> - instructions for conducting mineral hardness test
- <http://www.fossweb.com/modules3-6/SolarEnergy/index.html> - Students are challenged to design a racer that can complete a 2790 km race in Solar Powered Race. In Resource ID, students can classify resources as renewable, nonrenewable, or inexhaustible.
- <http://www.fossweb.com/modules3-6/EarthMaterials/index.html> - Students can use the Rock Database as a resource for locating information on the types of rocks. In Moh's Drill and Castle of Doom, students determine the hardness of the walls by scratching the wall with common objects and decide which drill bit to use for each layer of the wall.
- <http://www.fi.edu/weather/todo/todo.html> - contains instructions for making a barometer, hygrometer, rain gauge, weather vane, and compass
- http://www.pacifier.com/~tpope/Moon_Page.htm - contains Galileo's drawings of the Moon.

**Grade 4
Science
Unit 7: Structure and Form of Living Things**

Time Frame: Approximately three weeks



Unit Description

This unit introduces the study of living things, emphasizing and comparing their form, functions, structures, and adaptations.

Student Understandings

Students will identify the basic parts of a plant and describe their functions. Students will investigate and research plant and animal adaptations and explain how these adaptations allow the organisms to survive in their habitats. Students will draw and label a diagram of the human circulatory and respiratory systems and describe the functions of the organs.

Guiding Questions

1. Can students explain how plants get food?
2. Can students describe the purpose of plant leaves, stems, and roots?
3. Can students explain why animals have different parts, such as wings or webbed feet?
4. Can students name the organs of the respiratory system?
5. Can students name the organs of the circulatory system?
6. Can students describe how plants or animals adapt to their environment?

Unit 7 Grade-Level Expectations (GLEs)

GLE #	GLE Text and Benchmarks
Science as Inquiry	
1.	Ask questions about objects and events in the environment (e.g., plants, rocks, storms) (SI-E-A1)
2.	Pose questions that can be answered by using students' own observations, scientific knowledge, and testable scientific investigations (SI-E-A1)
3.	Use observations to design and conduct simple investigations or experiments to answer testable questions (SI-E-A2)
4.	Predict and anticipate possible outcomes (SI-E-A2)
5.	Identify variables to ensure that only one experimental variable is tested at a time (SI-E-A2)

GLE #	GLE Text and Benchmarks
6.	Use a variety of methods and materials and multiple trials to investigate ideas (observe, measure, accurately record data) (SI-E-A2)
7.	Use the five senses to describe observations (SI-E-A3)
8.	Measure and record length, temperature, mass, volume, and area in both metric system and U.S. system units. (SI-E-A4)
9.	Select and use developmentally appropriate equipment and tools (e.g., magnifying lenses, microscopes, graduated cylinders) and units of measurement to observe and collect data (SI-E-A4)
10.	Express data in a variety of ways by constructing illustrations, graphs, charts, tables, concept maps, and oral and written explanations as appropriate (SI-E-A5) (SI-E-B4)
11.	Combine information, data, and knowledge from one or more of the science content areas to reach a conclusion or make a prediction (SI-E-A5)
12.	Use a variety of appropriate formats to describe procedures and to express ideas about demonstrations or experiments (e.g., drawings, journals, reports, presentations, exhibitions, portfolios) (SI-E-A6)
13.	Identify and use appropriate safety procedures and equipment when conducting investigations (e.g., gloves, goggles, hair ties) (SI-E-A7)
18.	Base explanations and logical inferences on scientific knowledge, observations, and scientific evidence (SI-E-B4)
Life Science	
40.	Explain the functions of plant structures in relation to their ability to make food through photosynthesis (e.g., roots, leaves, stems, flowers, seeds) (LS-E-A3)
41.	Describe how parts of animals' bodies are related to their functions and survival (e.g., wings/flying, webbed feet/swimming) (LS-E-A3)
42.	Describe how the organs of the circulatory and respiratory systems function (LS-E-A5)
52.	Describe how some plants and animals have adapted to their habitats (LS-E-C2)
53.	Identify the habitat in which selected organisms would most likely live and explain how specific structures help organisms to survive (LS-E-C2)

Sample Activities

Activity 1: The Parts of a Plant (GLEs: 1, 2, 3, 4, 5, 7, 9, 10, 11, 12, 13, 18, 40)

Materials list: photos of living plants or living plants, plants with roots intact, plants with roots removed, food coloring, celery stalks or carnations, water, cups, plant with soft leaves, aluminum foil, hand lenses, plastic knives, safety goggles, disposable gloves, Amazing Plant Parts Research Sheet BLM (1 per student), science learning logs

Part A: Basic Overview of Plant Parts

Safety note: Have students identify safety procedures or equipment to be used when handling plants. (Wash hands, use disposable gloves, keep hands away from mouth, and identify allergies.) Have students identify the safety precautions necessary when handling sharp objects. (Point sharp object away from people and carry the sharp object with the point down.)

Review with students the basic parts of a plant and have students create a labeled drawing of a plant. Distribute a copy of Amazing Plant Parts Research Sheet BLM to each student. Using teacher selected reading materials and the website <http://www.urbanext.uiuc.edu/gpe/case1/c1facts2a.html>, have students research how the plant parts are related to meeting the plant's needs. For example, How does the plant get water? How does the water get to the leaves? How do plants get nutrients? How is the light absorbed by the plants? and How does the plant get carbon dioxide? Students should record their answers on the Amazing Plant Parts BLM. Students will revisit this research sheet at the end of the activity.

Part B: The Vascular System

Explain that plants are different from animals because plants are adapted to making their own foods from the Sun's energy and non-living matter found in the environment. Explain more fully the process of photosynthesis (Sun's energy collected by chlorophyll + carbon dioxide+ water → sugar+ oxygen+ water). The students will identify and describe the non-living matter that is used to create sugar, or plant food. Ask students to consider how the components that are used to make sugar enter the plant. Ask students what they or their parents do to keep the plants at their homes alive. Students will likely include the idea that they water their plants and that most plants live in soil. Ask them to tell where they pour the water when watering plants (near the bottom of the plant) and why they pour it there.

Show the students photographs of plants or display living plants in the classroom. If a living plant is used, break off and crush one leaf allowing the fluids inside to be visible to the students. Allow the students to think of questions that they might have regarding the water in the soil and the water in the leaves at the top of the plant. Students will likely wonder how the water from the ground reaches the top of the plant. Have students predict what parts of the plant aid the plant in bringing in water and carrying it to the rest of the plant. The students may then design investigations, focusing on the role of the stem and roots in the carrying of water, to test how water and nutrients enter and are carried throughout a simple small plant.

(1) Have students identify safety procedures or equipment to be used when handling plants. (Wash hands, use disposable gloves, keep hands away from mouth, and identify allergies.) Guide the students to explain how the water in the soil is taken in by the plants (the roots). Ask students to consider what might happen if a plant's roots were removed? Would the plant still be able to absorb the water it needs to conduct photosynthesis? How would the leaves of the plant look if they were not receiving water? Instruct the

students to record their predictions in their science *learning logs* ([view literacy strategy descriptions](#)). Ask students to devise a plan for investigating this question. Students should determine the independent and dependent variables, establish a control, and design a procedure. Have students share their procedures and decide which procedure is the best for answering this question. Review and approve student plans before students implement their investigations. Students will complete the investigation and record their observations in drawings and in writing in their science *learning logs*. One possible experiment is for students to explore how roots are used to absorb water by conducting an investigation using plants with roots and also plants with the roots removed. Place each plant in a cup of water and observe the leaves of each plant for several days. Students should observe the differences in the appearances of the leaves of the two tested plants, noting especially the firmness of the leaves. Have students share their findings. Have a discussion about the importance of roots to plants.

(2) Guide the students to consider how the water taken in by the roots of the plant is carried to the leaves where photosynthesis is taking place. Have students explore the vascular system of the stem by using red food coloring in water, and then place celery stalks, and/or white carnations into the water. Students should predict the outcome of this experiment. The celery and/or carnations will be left in colored water for one hour. At fifteen-minute intervals, students will observe any changes in color in the plant and make notations on a chart in their science *learning log*. Allow the plant to stay in the water overnight. Have students identify the safety precautions necessary when handling sharp objects. (Point sharp object away from people and carry the sharp object with the point down.) The following day, students should observe any color changes in the stem or flower and use a plastic knife to slice the end of the celery or flower stem for closer observation with a hand lens. Students will carefully note what is seen in their science *learning logs*.

Facilitate a discussion of the changes that occurred, and encourage students to formulate a hypothesis of what might happen if other plants were used. Through questioning, guide students to identify the vascular tubes in the plant. Explain to students that some plants (vascular plants) have tubes that are used to transport water from the roots to other parts of the plant. The students will conclude that one function of the stem is to transport water throughout the growing plant. Help the students to compare vascular structures in the plant to plumbing or highways used for transportation and relate it to the human vascular system.

Part C: Leaves

Review with students the role of leaves in photosynthesis. Discuss the structure of the leaf and its role in obtaining carbon dioxide and in releasing water and oxygen through the stomata. Have students research the role of chlorophyll in photosynthesis and its location in the plant. Have students share findings. Remind students of the experiment from Unit 4 where the leaves of the plants were covered with aluminum foil and placed in the window. Discuss the results of the lab. (The leaves turned yellow where they were covered, an indication that photosynthesis did not occur.) Applying their knowledge of

the results of Sun deprivation on the color of the leaf, students should draw conclusions about the color of grass in their yards where a board or other object has blocked the grass from receiving sunlight. Arrange for this observation on the school grounds.

This is a good opportunity to dispel students' misconceptions about commercial products that are advertised as being plant food. Plants produce their own food, namely sugars. The commercial products are fertilizers or minerals that aid in growth and well being of the plants. They carry out a similar function as vitamin supplements do for humans. Neither provides energy. Reinforce the concept that the Sun provides the energy for photosynthesis. A study of the Venus Fly Trap, pitcher plant, and sundew are appropriate to show how some plants that are found in nitrogen poor soils, such as Louisiana bogs, have adapted to capturing other living things to obtain the needed elements that are lacking.

Students should revisit their Amazing Plant Parts Research Sheet and discuss their research in small groups. Have students summarize the research and the above activities by writing a conclusion in their science *learning logs* about the role of the roots, stems, and leaves in the process of photosynthesis.

Activity 2: Plant Structures/Adaptations (GLEs: 1, 2, 3, 4, 5, 6, 7, 8, 9, 10, 12, 13, 18, 40, 52, 53)

Materials list: succulent plants (Kalanchoe or Aloe Vera), wooden sticks, petroleum jelly, paper towels, water, meat tray, graduated cylinders, potted plants, seeds, paper towels, resealable plastic bags, copy paper, markers or colors, Plant Adaptation Brochure BLM, science learning logs

Part A: Leaf Adaptation

Ask students to consider the reasons that they apply a lip balm to their lips and lotion to their skin especially in the winter and in the summer, if they spend time in the Sun. They should conclude that they are trying to stop the loss of moisture that causes dry skin. Have them observe leaves from a succulent such as a Kalanchoe or Aloe Vera. Allow students to rub off some of the wax-like coating from the plants using a wooden stick or their finger nails. The students will generate questions as to why a plant would have such a coating and then suggest what environments would require this adaptation that would allow a plant to hold onto its water by covering its stem and leaves with wax (deserts, alpine environments).

Guide the students to devise a test to determine how effective the wax covering can be in dry environments. Have students write a prediction about the effectiveness of the wax covering. The students will identify the controls, independent and dependent variables to ensure that the test is fair. One possible experiment is to have students use petroleum jelly to represent the wax covering and wet paper towels placed on flat surfaces such as meat trays to represent the plant. Students should pour a measured amount of water onto 2 folded paper towels and record the amount in a data table in their science *learning logs*

([view literacy strategy descriptions](#)). Coat one folded wet paper with petroleum jelly that seals the edges of the wet paper to the tray. The other folded wet paper towel should not be coated with petroleum jelly. The papers would be set out in an air conditioned room, but should not be placed near a lamp, flame, heat source, or in direct sunlight. The student will make observations daily as to the appearances of the papers. After two or three days, the students can lift the papers from the trays and record observations (evidence of water, etc.) in their science *learning logs*. The students will squeeze each sheet and measure the water that remains in the sheets using appropriate equipment. The data will be recorded in the student created data table to contrast the amounts of water at the beginning of the investigation to what remains at the conclusion. The students should conclude that a wax coating is an adaptation to help a leaf retain water in a harsh environment.

Students may research other adaptations that protect plants from water loss. These would include researching the plants that have needle-like leaves (i.e., firs, pines, spruce) and those which drop their leaves in the winter to retain water, such as many deciduous trees.

Part B: Leaves and Stems

Safety note: Have students identify safety precautions necessary when making plants observations. (Do not touch unknown vines because they could be poisonous.)

Have the students observe vines growing in trees and bushes on the school campus or in photographs provided by the teacher. If observing plants in the environment, ask students to identify what precautions they should take when observing plants and vines. (Students should not touch vines as they could be poison ivy or other poisonous plants.) Have them recall the role of stems in carrying water and the role of leaves in producing food. Students should discuss why they think the vines are climbing up the other plants and how this adaptation helps the plant to survive. The students should infer that the malleable stem of the vine helps to bring the plant up into the light, which helps the plant to make food, and reduces the competition for light that it would have with the tree or bush if it had only grown close to the ground.

Using the plants growing in the classroom, students can observe adaptive plant behaviors such as phototropism and geotropism.

Phototropism is a plant adaptation in which the plant or plant parts, such as leaves grow toward the Sun. Students should predict what will occur if they turn the leaning side of the plant away from the window. Students should record their predictions in their science *learning logs*. Have students turn the plants and record observations each day. Students should conclude that the stems of plants are capable of leaning or growing toward a source of light to ensure that the leaves receive maximum light to conduct photosynthesis.

Part C: Roots

Geotropism is a plant adaptation in which the roots always grow down toward Earth's center of gravity. Students will germinate seeds and observe the directions in which the root and stem grow. They should question if this phenomena always happens and design an investigation to determine if the root and stem always manage to turn in the directions that is assumed the plant parts will grow. For example, students can place seeds on damp paper towel sheets within a sealed plastic bag. The bags can be taped hanging from a windowsill or chair back that is near the window in the classroom, cafeteria, or other well-lighted place on campus. As the seed sprouts and grows, the students will observe and draw their observations for several days. The bag should be turned so that the existing downward growing root is now turned upward in order to determine if the direction of the root and stem will be altered. The seedling will be observed and drawn daily. The turning of the bag should also be recorded. To prevent the paper towel from drying out, add water to the bag when necessary.

Ask students to list ways the plant adaptations of geotropism and phototropism benefit plants. Distribute a copy of the Plant Adaptation Brochure BLM to each student. Students will use *RAFT* writing ([view literacy strategy descriptions](#)) to create a Plant Adaptation Brochure for their peers from the perspective of a plant describing the adaptive processes of geotropism and phototropism. In the brochure to their peers, direct students to draw and label the parts of a plant, explaining the function of the parts of a plant, describe the processes of geotropism and phototropism, explain how the adaptations ensure the survival of the plant, and explain how to shape a plant by periodically turning it. The students' role is the plant, the audience is their peers, the format is brochure, and the topic is the benefits of geotropism and phototropism. Allow students to share their brochures with the class.

Activity 3: Animal Adaptations (GLEs: 1, 2, 3, 7, 10, 11, 13, 18, 41, 52, 53)

Materials list: Bird Beaks and Feet worksheet (1 per student, must be printed from listed website), empty paper towel rolls (1 per student group), cotton balls, glue, seeds, nuts, staple removers, flat stones, scissors, markers, crayons, copy paper, tape or glue, unsharpened pencils, field guides, Internet access, poster board, science learning logs

Safety note: Have students identify the safety precautions necessary when handling nuts. (Students should check for food allergies prior to the investigation and do not eat the seeds or nuts.)

Remind students that one way animals are different from plants is that animals cannot produce their own food. Ask students to think of ways that animals get the energy that they need. (Hunt, eat plants) Remind students that they have studied the structures that allow plants to carry out photosynthesis. Have them consider the body structures that allow animals to get their food. (They may mention teeth, the ability to run fast, camouflage, etc.)

Review the terms *producer*, *consumer*, *herbivore*, *carnivore*, and *omnivore*. Continue to ask probing questions that will lead the students to wonder how the teeth of the animals are designed to aid in getting and chewing the food that the animal needs. Have students design a model of meat on a bone using cotton balls glued to an empty paper towel roll. Students should collect samples of plant material from the school grounds or their homes that could be used as food for herbivores. Bring in various seeds and nuts such as sunflower seeds. *Safety Note: Due to food allergies, do not use peanuts.* The students will use models of teeth to determine their effectiveness in collecting food and smashing the food for ease in swallowing. Each group will need a staple remover (canine teeth), two somewhat flat rocks (molars), and scissors (incisors). The student will test each model tooth and describe how well each was able to grasp and smash the food type. Students will record their observations in a table in their science *learning logs* ([view literacy strategy descriptions](#)). The class will discuss the effectiveness of each tooth type and note the type of food that each tooth is best suited to chew. Have students list examples of animals that have each type of teeth and compare the teeth to the primary diet of the animals.

Access the website http://www.biologycorner.com/worksheets/beaks_feet.html and print out the Bird Beaks and Feet activity worksheets. Create picture cards of the birds and give each group one set. In groups, students will compare the picture cards of the birds and list and discuss their similarities and differences. Students should point out that the beaks and the feet of the birds are different in size and shape.

Ask students what might a bird's beak and feet tell us about their diet and habitat? Provide each group with the data table on the functions of the different beaks and feet. Have students complete the second data table and write inferences about the diet and habitat of each bird pictured on the cards. Direct students to analyze the data in the chart and answer the questions provided on the worksheets. Facilitate a class discussion on the adaptations of each bird and how they help the bird to survive.

The students should research a Louisiana animal to determine what that animal eats in its natural environment. The students will compare the tooth effectiveness to the diet of the animal and make predictions as to the type of tooth that is prevalent for that type of consumer. The students should discuss how their chosen animal's teeth are adaptations that help them to survive in their habitats.

Review the terms *prey* and *predator*. Have the students consider how fur color is an adaptation that can protect a prey from a predator or help conceal the predator during a hunt. Students will choose a spot in the classroom to place their animal, where their animal will be able to blend and hide. (The students must not place their animals inside of any furniture.) Have students use markers or crayons to design a paper skin for their animal that will camouflage it. The skin will be wrapped around a pencil using tape. Direct students to hide their pencils in their selected spot in the classroom. Students will take turns trying to find one of the hidden animals. As students locate the pencils, have them place them in a pile. After the game, if a student's animal was not found, have the student locate the animal and place it in a pile separate from the ones that were found.

Have students compare the two piles and lead a discussion on which skins were the most effective and the reasons why. Students will conclude that coloring is an important adaptation to one’s environment. Have students write a short essay explaining how the animal that they chose in the first activity can blend in with its habitat.

Students will research a chosen bird or other animal that can be found in Louisiana. Working in cooperative groups, have the students use field guides, the Internet, multimedia resources, and other available resources to compile a list of questions related to the adaptations (e.g., camouflage, teeth, wings, legs, feet, breathing method, etc.) of the chosen animal that have allowed it to survive in its habitat over time. For example, students may research animals that have webbing in their feet such as frogs, beavers, otters, ducks, etc., birds that are waders such as the Great Egret, with its long legs, or animals that burrow in the mud such as crawfish. Using *Split Page Notetaking* ([view literacy strategy descriptions](#)), the students may be guided to collect information on their chosen animal. Have students divide their paper in half from top to bottom. On the left hand side of the paper, have students write the topics for research. (For example, the animal’s method of mobility, the reason for the webbing of the animal’s feet and the necessity for wading birds to have long legs.) As the students research their information, have them record the information next to the correct question in their science learning logs. For example,

<p>How does having long sharp teeth help the beaver?</p> <p>What benefit is a long tail to a beaver?</p> <p>How is a beaver’s nose designed to help it stay under water for long periods of time?</p>	
---	--

Students will draw pictures, emphasizing and labeling the adaptations, or use photographs of the animals that clearly illustrate the traits. The students will present their findings to the class using posters or multi-media presentations. The students will explain how the animal’s adaptation allows it to survive in a given habitat.

Activity 4: Circulatory and Respiratory Systems (GLEs: 6, 7, 10, 11, 12, 13, 42)

Materials list: Internet access, stethoscope, stopwatch, Exercise Your Heart BLM (1 per student), plastic pop bottle with cap, plastic straws, balloons (small and large), rubber bands, modeling clay, colored pencils, scissors

Safety Note: Provide careful directions when preparing the students to use the stethoscopes. Have students identify the safety precautions necessary. (Students should not tap or touch the end! A very loud sound will result.). Be cognizant and sensitive of any student who may have medical issues that would prohibit him/her from doing the exercises.

Using textbooks and resource materials, such as health books, Internet sites, or trade books, students will review the organs and functions of the circulatory and respiratory systems. Make connections to the needs of the previously studied plants and animals and to the recognition that plants are the primary source of oxygen in the world.

Note: If stethoscopes are not available, model how to take a pulse count using the pointer and middle fingers on the wrist or neck. The thumb should not be used since it has its own pulse.

Using a stethoscope and stopwatch, students will experience listening to their heartbeats and taking their pulse before and after exertion and rest. Have students identify safety precautions necessary when using stethoscopes. (Students should not tap or touch the end! A very loud sound will result.) In groups, have students take turns using a stethoscope and stopwatch to count their heart rate before exercising and record the information on the Exercise Your Heart BLM. One student will complete ten jumping jacks and then measure and record his/her heart rate. Repeat the activity completing 20, 30, and then 40 jumping jacks. Each student in the group will complete the activity and record data in the data table. Group members will graph their data. Students should conclude that heart rate rises with activity. Students should also discuss how they felt before and after exercising relative to body heat.

The students will again diagram the flow of blood through the heart and body for reinforcement. Facilitate a discussion of how blood circulates and the effect of exertion on the circulatory and respiratory systems.

Students will model how the respiratory system works by creating a model of a lung using a plastic pop bottle with cap (the chest or ribs), a straw inserted through a small hole in the bottle cap, a balloon attached with a rubber band to the straw portion that is inside of the bottle, and a cut open balloon stretched across and attached to the opening of the cup (the diaphragm). See the following website for specific directions:

http://www.omsj.edu/visit/life/obp/u2_11_body.html for a picture of the model. *Teacher note: The day before, drill a hole in each of the plastic pop bottle caps large enough for the straw to fit through and cut off the bottoms of the bottles using scissors.*

Introduce the term *inhale*. The students can observe this movement of the diaphragm when they breathe in. They may also observe the collapsing of the lung balloon when the diaphragm is slightly pushed into the cup. Introduce the term *exhale*. Students will draw diagrams in their science *learning logs* ([view literacy strategy descriptions](#)) with labels for the parts of the body that were modeled in the activity (rib cage, lungs, diaphragm), and they will explain how the diaphragm's movement affects the expansion and compression of the lungs during inhalation and exhalation. Ask students to describe

different breathing apparatus or adaptations that some animals have such as gills for fish and trachea openings for insects.

Sample Assessments

General Guidelines

Assessment techniques should include use of drawings/illustrations/models, laboratory investigations with reports, laboratory practicals (problem-solving and performance-based assessments), group discussion and journaling (reflective assessment), and paper-and-pencil tests (traditional summative assessments).

- Students should be monitored throughout the work on all activities via teacher observation of their work and lab notebook entries.
- All student-developed products should be evaluated as the unit continues.
- For some multiple-choice items on written tests, ask students to write a justification for their chosen response.

General Assessments

- The students will observe and illustrate observations of the changes in the direction of root and stem growth.
- The students will make a brochure labeling the parts of a plant, giving the function of each part, and explaining how to shape a plant by rotating it.
- The students will create models of the human respiratory system.
- The students will each research a given topic using available resources.

Activity-Specific Assessments

- Activity 1: Using an illustration of a plant, the students will explain the function of the roots, leaves, and stem in the process of photosynthesis.
- Activity 2: Given a drawing of ivy climbing a fence, the students will explain the adaptive behavior in terms of the requirements necessary for photosynthesis.
- Activity 3: Presented with model drawings of various teeth, fur colors, and leg types, the student will cut out the models, attach to a given animal body to design an imaginary animal. The student will describe the animal's environment and food sources, based on the teeth and leg types chosen.

Resources

- Maurer, Tracy. *The Heart and Lungs*. Vero Beach, FL: Rourke Corp., 1999.
- Ross, Michael Elsohn. *Body Cycles*. Camp Hill, PA: Millbrook Press, 2002.
- Watts, Claire. *Plants (Make It Work!)* Chicago: World Book, Inc., 2001.
- *Eyewitness Visual Dictionary of Plants*. New York: Dorling Kindersley, Inc. 1992
- <http://www.medtropolis.com/VBody.asp> - students can explore the human body with this interactive virtual body
- <http://www.lessonplanspage.com/ScienceAnimalAdaptations58.htm> - Designer Animal - Animal Adaptation activity description
- http://www.biologycorner.com/worksheets/beaks_feet.html - bird beaks and feet activity worksheet
- http://www.oms.edu/visit/life/obp/u2_11_body.html - a picture of the model lung set up is provided along with a step by step lesson and quiz
- <http://www.urbanext.uiuc.edu/gpe/case1/c1facts2a.html> - provides information on how plant parts are related to their function

**Grade 4
Science
Unit 8: Foods and Nutrition**

Time Frame: Approximately two weeks



Unit Description

This unit introduces a basic understanding of the nutrients needed for an individual's growth, development, and energy. Simple menus will be planned and compared to the USDA's My Pyramid. Additional activities include reading and analyzing the nutritional labels on purchased food products.

Student Understandings

Students will learn that foods may be grouped according to whether they are primarily carbohydrates, fats, proteins, or rich in vitamins and minerals. Students should develop the ability to identify the functions for each type of food component explored and understand why some nutrients are essential to our diets and the diets of many other animals. They will gain skill in identifying the recommended number of daily servings of various food groups as identified in the revised My Pyramid. Students should understand that many plants are useful providers of carbohydrates, fats, proteins, and vitamins for the human diet.

Guiding Questions

1. Can students explain the My Pyramid and what it means to them?
2. Can students read and interpret a nutritional label?
3. Can students make good nutritional choices?
4. Can students describe how nutrients are used by the body?

Unit 8 Grade-Level Expectations (GLEs)

GLE #	GLE Text and Benchmarks
Science as Inquiry	
1.	Ask questions about objects and events in the environment (e.g., plants, rocks, storms) (SI-E-A1)
2.	Pose questions that can be answered by using students' own observations, scientific knowledge, and testable scientific investigations (SI-E-A1)
3.	Use observations to design and conduct simple investigations or experiments to answer testable questions (SI-E-A2)

GLE #	GLE Text and Benchmarks
4.	Predict and anticipate possible outcomes (SI-E-A2)
6.	Use a variety of methods and materials and multiple trials to investigate ideas (observe, measure, accurately record data) (SI-E-A2)
7.	Use the five senses to describe observations (SI-E-A3)
9.	Select and use developmentally appropriate equipment and tools (e.g., magnifying lenses, microscopes, graduated cylinders) and units of measurement to observe and collect data (SI-E-A4)
10.	Express data in a variety of ways by constructing illustrations, graphs, charts, tables, concept maps, and oral and written explanations as appropriate (SI-E-A5) (SI-E-B4)
11.	Combine information, data, and knowledge from one or more of the science content areas to reach a conclusion or make a prediction (SI-E-A5)
12.	Use a variety of appropriate formats to describe procedures and to express ideas about demonstrations or experiments (e.g., drawings, journals, reports, presentations, exhibitions, portfolios) (SI-E-A6)
13.	Identify and use appropriate safety procedures and equipment when conducting investigations (e.g., gloves, goggles, hair ties) (SI-E-A7)
14.	Identify questions that need to be explained through further inquiry (SI-E-B1)
15.	Distinguish between what is known and what is unknown in scientific investigations (SI-E-B1)
21.	Use evidence from previous investigations to ask additional questions and to initiate further explorations (SI-E-B6)
Life Science	
43.	Explain the primary role of carbohydrates, fats, and proteins in the body (LS-E-A6)
44.	Analyze food labels to compare nutritional content of foods (e.g., amounts of carbohydrates, fats, proteins) (LS-E-A6)

Sample Activities

Activity 1: Diet Diary (GLEs: 1, 2, 10, 11)

Materials List: science learning logs

Ask students how plants get the energy that they need to live and repair their tissues. Facilitate a discussion about the energy needs of animals and plants. Ask students to develop questions that they may have about people and energy and plants and energy. Elicit their questions and record them on a chart. (They will probably question the sources of our energy since it isn't seen as being obtained directly from the Sun as with plants, or because they haven't considered how our bodies rely on plants and animals for energy.)

Direct students to keep a record in their science *learning logs* ([view literacy strategy descriptions](#)) for four days of all the food that they eat. In class, have small student groups discuss their list among each other. After sharing, ask students to think about the origins of the ingredients that made up the foods they have listed. Since our bodies don't make our own food, where does it come from? In pairs, have students discuss their answers.

Activity 2: My Pyramid Guide (GLEs: 10, 11)

Materials List: My Pyramid Guide BLM (1 per student), My Pyramid for Kids Worksheet BLM (4 copies per student), paper plates, magazines (optional), science learning logs

Introduce the My Pyramid Guide BLM (a colored copy can be downloaded from http://teammnutrition.usda.gov/Resources/mpk_poster2.pdf) and discuss the groups into which foods are organized and the various types of foods illustrated. Elicit responses from students about which foods belong in the various groups and which foods they eat often and enjoy. Students should refer to their four day food diary and predict how close they came to eating a variety of the foods that meet the requirements for each of the five food groups each day.

Using the My Pyramid for Kids Worksheet BLM (a copy can also be downloaded from http://teammnutrition.usda.gov/resources/mpk_worksheet.pdf), have students list foods they ate for the first day in their diary in the left hand column. Then, using their copy of the My Pyramid Guide, have students classify the foods found in their diaries in the 5th column. They should also fill in the last column estimating their totals and create a bar graph of their totals for each group and analyze their graphs to determine if there is a food type that is over or under represented in their diets. This activity should be repeated for the remaining three days of their diary. In their science *learning logs* ([view literacy strategy descriptions](#)), have students explain what the My Pyramid guide means to them and how it can help them in everyday life.

Working in cooperative groups, students will design meals for one day to include a variety of the suggested foods in a balanced diet. Meals can be depicted on paper plates by drawing and coloring or by making a collage from magazine pictures. The plates will then be displayed with a wall visual of the pyramid.

Activity 3: Why is the Nutritional Food Label Important? (GLEs: 1, 10, 11, 44)

Materials List: transparency or poster of Nutrition Food Label BLM, an assortment of food labels

Using an overhead transparency or poster of the Nutrition Food Label BLM (a copy can be downloaded from

http://www.girlshealth.gov/nutrition/nutrition_facts_textversion.htm), introduce the students to the food labels appearing on the assorted food items. Discuss and define the vocabulary found on the labels. Discuss what nutrients the various food groups mentioned in Activity 2, My Pyramid Guide, provide.

Using the above mentioned website, explain to the students the importance and function of each part of the food label. Assist students in understanding the meaning of daily values and the USDA's reasons for listing vitamins, minerals, calories, fats, cholesterol, sodium, protein, and carbohydrates. Discuss why calories, certain minerals and some nutrients must be restricted in diets to control and/or avoid health problems such as obesity, diabetes, coronary disease, and high blood pressure. Point out that reading the labels can also help those who are trying to increase the amounts of certain nutrients in their diet.

Students may begin asking questions about the foods in their diet. Provide labels for some of the foods listed previously in their food diary and instruct students to search the labels for answers to various nutritional questions (ex. How much fat is in one serving of this product? How many calories are in 2 servings of this product?) that will help them to evaluate the nutritional value of the food.

Using the website, http://kidshealth.org/parent/nutrition_fit/nutrition/food_labels.html, direct students to create a list of which nutrients they need to eat plenty of and which nutrients they need to restrict. Then have them analyze the foods in their diets for these various nutrients and decide if they are making healthy food choices.

To close this activity, students should write letters to their parents describing what they have discovered and informing their parents of the importance of restricting sodium, calories, fats, and cholesterol. Parents may find the following site recommended for them by the USDA of value:

http://kidshealth.org/parent/nutrition_fit/nutrition/food_labels.html.

Activity 4: What's In The Food? (GLEs: 1, 2, 3, 4, 6, 7, 9, 10, 11, 12, 13, 14, 15, 21, 43, 44)

Materials List: various food labels, My Pyramid Guide BLM, iodine, potato, various food items (starches, fatty foods), brown paper bags, mayonnaise, disposable gloves, safety goggles, science learning logs

Safety notes: In this unit students will be testing various foods. Have students identify the safety precautions necessary when handling food items and chemicals such as iodine. (Check student records so that the safety of students with food allergies {nuts, wheat, etc.} is addressed. Students should not eat any of the foods that they will be testing. Iodine is poisonous, if ingested. During the testing for starch with the iodine, wear disposable gloves and safety goggles.)

Part A: Using a variety of nutrition labels from various food products, point out to students that the nutrients are listed differently from the way the food groups are organized on the food pyramid. Have students locate the words *protein*, *carbohydrates*, *fats*, and *vitamins*, and examples of *minerals* on the label. Using textbooks, nutrition brochures, or the Internet sites (http://www.kidshealth.org/kid/stay_healthy/ and/or http://kidshealth.org/kid/stay_healthy/food/labels.html), students will use *split-page notetaking* ([view literacy strategy descriptions](#)) to answer questions related to the roles that these nutrients and water serve for the maintenance of a healthy body. To create the split-page format, have students draw a straight line from top to bottom of a piece of notebook paper approximately 2-3 inches from the left edge. The page should be split into one-third/two-thirds. In the left column, instruct students to write questions related to the role the nutrients and water play in maintaining a healthy body and the answers should be written in the right column.

How does the body use fats?	<ul style="list-style-type: none"> - fuel the body - help absorb some vitamins
Why does the body need protein?	<ul style="list-style-type: none"> - help maintain muscles, bones, blood, and body organs

Students may then use the split-page notetaking sheet as study aid. They can bend the sheet so that the right or left column is covered and then use information in the other column to recall the covered information. Students can also use their notes to quiz each other in preparation for quizzes and other class activities. The students should discover that most dietary experts believe that the body needs 6- 8 glasses of water a day to function properly. Water is used in digestion, to carry nutrients to cells, to carry waste away, and to help the body maintain the right body temperature. Explain that proteins contain nitrogen and that bacteria are the only organisms that can convert gaseous nitrogen in the air to a nitrogen compound that plants and animals can use. Proteins are structural material for cells and muscle tissue as well as a regulator of chemical reactions in the body. Fats are used as fuel, and as building materials. Fats also are used to form sheets of tissue that surround and protect the heart, lungs, and intestines. In the body, excess sugar and proteins may be stored as fat. Fats contain or transport fat-soluble vitamins A, D, E, and K. The human body uses carbohydrates as a source of energy. Also, students should locate known examples of food containing the nutrients protein, fats, and carbohydrates. The students should share their lists and, using their My Pyramid Guide BLM from Activity 2, classify these foods into the groups provided by the food pyramid.

Part B: Explain to students the safety equipment and precautions necessary when using iodine. (Disposable gloves and safety goggles are needed and none of the materials should be eaten.) Place a few drops of iodine solution onto a slice of potato and have students record their observations in their science *learning logs* ([view literacy strategy descriptions](#)). Conduct a class discussion about their observations, and then explain to students that the chemical iodine can be used to detect starch. Ask students to infer the

reason the potato changed color. (*It contains starch.*) Explain that starch is a substance that the plant can make from sugar during photosynthesis and store to use later as food. Starch and sugars are both examples of the nutrient carbohydrate and just like plants, the human body uses carbohydrates as a source of energy.

Bring in samples representing some of the foods that students listed in their food diaries. Direct students to identify what they know and don't know about their food samples. (They know that some foods contain starches; iodine is an indicator of starch in a food; humans need to eat foods with starches [carbohydrates] for energy. They don't know which of the food items contain starch.) Ask students what kind of observations and questions they could make using the iodine test and the foods that they eat. (Students should state that they could find out if their food samples contain starch). Ask them if the starch test will also indicate which foods came from plants. (They should be able to justify their answers.) Guide students to design the procedures, list materials, and set a standard for the color change for their investigation.

In their science *learning log*, the students will design a table to record their observations and will also predict which of the foods from the samples above they think will contain starch. (Place a drop of iodine on a piece of plastic to serve as a control; a drop of iodine on paper, a plant product, noting the color changes to purple or near black.) The students will follow their lab design to investigate which of their food samples contain starch. The students will compare the results for all trials done by each group. In their science *learning log*, have students write a conclusion as to which foods came from plants and which came from other sources (animals). Ask students if a positive result from the iodine lab test is further proof that photosynthesis has occurred.

Part C: Instruct students to refer back to the investigation in Part B and using their prior experience have students list additional questions about the food samples that may be answered with further investigations. (Ex. Do the food samples contain fats or proteins?) Have students refer back to their *split-page notetaking* sheet and determine the role of fat in the diet.

Demonstrate the test for fat by placing a small amount of mayonnaise or other fat containing food on absorbent brown paper. Allow the food item to sit overnight. Observe the greasy circle that has spread around the food. Direct students to decide which food items from their diaries they would like to test for fat content. Since misconceptions exist in society that fats come only from animals, be sure to include foods such as nuts, potato chips and olives to test if not listed by students. Caution: Be aware of any peanut allergies with students. In their science *learning log*, have students prepare a chart labeled with the food items, the fat test results, and the food content columns. Again ask students to identify the safety equipment and procedures needed when using food in the lab. The students will determine how much of each item they will test to maintain consistency among the tests and measure the amounts. Students should replicate their trials three times. Supervise the students as they test each item. The students will compare the results and make conclusions about fat and starch content in foods.

Revisit the student generated questions from Activity 1 and have students identify the questions that need to be explained through further inquiry.

Sample Assessments

General Guidelines

Assessment techniques should include use of drawings/illustrations/models, laboratory investigations with reports, laboratory practicals (problem-solving and performance-based assessments), group discussion and journaling (reflective assessment), and paper-and-pencil tests (traditional summative assessments).

- Students should be monitored throughout the work on all activities via teacher observation of their work and lab notebook entries.
- All student-developed products should be evaluated as the unit continues.
- For some multiple-choice items on written tests, ask students to write a justification for their chosen response.

General Assessments

- The student will correctly categorize various foods according to the My Pyramid using short answer responses.
- The student will determine the nutritional value of a variety of foods by measuring serving sizes and calculating totals using the food labels.
- The student will compare and draw conclusions about foods and nutritional balance of foods in a meal or over a period of time.
- The students will work in pairs to design a poster to advertise a healthy snack for children. The poster will include the nutritional value.

Activity-Specific Assessments

- Activity 2: Instruct students to use the USDA My Pyramid-suggested servings to create balanced meals for a day.
- Activity 3: Have students interpret food labels and determine which food items are the healthiest choices from a group of snack foods
- Activity 4: Ask students to explain the body's need for the nutrients, fats, carbohydrates, and proteins. Provide the student with a food item and direct the student to demonstrate that he/she can test an unknown food for fats and starches.

Resources

- *Digestion*. Video. Disney Educational Production, Buena Vista Home Video. 1995, 1994. Bill Nye the Science Guy series.
- Lambourne, Mike. *Down the Hatch: Find Out About Food*. Millbrook Press, 1992.
- *The Magic School Bus for Lunch*. Video. Scholastic Productions, Inc.
- Patent, Dorothy Hinshaw. *Nutrition: What's in the Food We Eat*. Holiday House, 1992.
- Sharmat, Mitchell. *Gregory, the Terrible Eater*. New York: Scholastic, 1980.
- Swanson, Diane. *Burp! : The Most Interesting Book You'll Ever Read about Eating*. Tonawanda, NY: Kids Can Press, 2001.
- *Dole 5-a-Day*: Available online at <http://www.dole5aday.com/>
- http://kidshealth.org/kid/stay_healthy/food/labels.html - information on the food labels and how to read a label is provided at an age appropriate reading level. The information pages can also be printed.
- <http://www.cfsan.fda.gov/~dms/foodlab.html> - detailed information on reading a food nutrition label.
- www.mypyramid.gov - Department of Agriculture and Nutrition's healthy body website loaded with printable worksheets, teacher information, and provides an online nutrition game students can play.
- <http://www.fossweb.com/modules3-6/FoodandNutrition/index.html> - students can play an interactive game to plan a balanced meal with given criteria
- http://www.girlshealth.gov/nutrition/nutrition_facts_textversion.htm - sample of nutrition food label